

LISTINO PREZZI

price list | preisliste | liste des prix

03_2024

Pietred'Arredo[®]
naturalmente ricostruite

“Io sono me più il mio ambiente e se non preservo quest'ultimo non preservo me stesso.”

- José Ortega Y Gasset -

COLMEF GROUP si impegna ogni giorno a rispettare e proteggere il nostro pianeta, compiendo scelte ecosostenibili su materiali e processi produttivi.

FSC® - Forest Stewardship Council®. Associazione che promuove in tutto il mondo una gestione responsabile delle foreste dal punto di vista ambientale, sociale ed economico. L'etichetta **FSC Misto** indica che il legno o la carta all'interno del prodotto provengono da materiale certificato **FSC**, materiale riciclato e/o legno controllato.

La tecnica di stampa **PREMIUM COLOR PRINT** usa inchiostri a base vegetale che rendono questo prodotto riciclabile a fine vita.

COLMEF GROUP commits to respecting and protecting our planet every day, making sustainable choices on materials and production processes.

FSC® - Forest Stewardship Council®. Is a world-wide association that promotes responsible environmental, social and economic forest management. All forest-based materials in products or packaging bearing the **FSC Mix** label either be from FSC-certified forests, verified as recycled or classed as controlled wood.

The printing technique **PREMIUM COLOR PRINT** uses plant-based inks that make this product recyclable at the end of its life cycle.

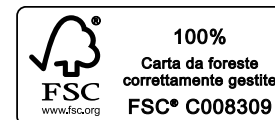

**PREMIUM
COLORPRINT**



stampato
con il sole

Stampato da
**grafiche
antiga**

**LA TRADIZIONE
TRADITION
DIE TRADITION
LA TRADITION**

ARENAL	14
GRANADA	15
SANTIAGO	16
TEIDE	17
JAVA	18
CERVINO	19
MADERA	20
TAOS	21
VESUVIO	22
SASSO DI FIUME	23
LOKON	24
OLKARIA	25
MISTO UMBRO	26
MISTO CAMPAGNA	27
CERVINO PANEL	28
BELMONTE	29
BORGONOVO	30
CORTEVECCHIO	31
CORTONA	32
TOSCANO	33
ETRUSCO	34
ALPINO	35
MONTANO	36
TIROLESE	37
DOLOMITE	38
VENETO	39
CANOVA	40
LIGURE	41

**IL MATTONE
THE BRICK
DER ZIGEL
LE BRIQUE**

RUSTICO	44
ANTICO MATTONE	45

**IL CONTEMPORANEO
CONTEMPORARY
DER ZEITGENOSSE
LE CONTEMPORAIN**

NEW CALEPIO	48
SAKAR	50
MURIA	51

**L'EFFETTO LEGNO
WOODEN EFFECT
DIE HOLZOPTIK
L'EFFET BOIS**

KALOS	54
VINTAGE	55
VICTORY	56

**MISTO A RICHIESTA
CUSTOMIZED BLEND
MISCHUNGEN AUF WUNSCH
MÉLANGE SUR DEMANDE**

MISTO A RICHIESTA	57
-------------------	----

**ELEMENTI SPECIALI
SPECIAL ELEMENTS
SONDERELEMENTE
ÉLÉMENTS PARTICULIERS**

ELEMENTO AQVA	60
ELEMENTO SAVANA	60
KRONOS	61
TERMINALE	61

**SISTEMI INNOVATIVI
INNOVATION SYSTEMS
INNOVATIVE SYSTEME
SYSTÈMES INNOVANTS**

AIR SYSTEM	64
PIETRA COMFORT	66

**PRODOTTI TECNICI
TECHNICAL PRODUCTS
TECHNISCHE PRODUKTE
PRODUITS TECHNIQUES**

ARREDOCOLLA	70
ARREDOFIX	70
ARREDOSTUCCO	71
ARREDOSTUCCO GRANA FINE	71
ARREDOLIGHT	71
ARREDOSIL	72
ARREDOCOAT	72
ARMOFLEX 330	73
SACCHETTI TRIANGOLARI	73
SACCHETTO TRIANGOLARE PROFESSIONALE	73
ROCKET	74
ROCKET WOOD	75

NATURALMENTE RICOSTRUITE

Naturally reconstructed | Natürlich Reproduziert | Naturellement reconstituées



LA NOSTRA STORIA

È in Umbria, nel cuore verde d'Italia, che nasce PIETRE D'ARREDO. Qui la storia, la cultura della pietra e con essa la tradizione del costruire, sono alla base dell'identità artigiana dei nostri avi, che con la loro manualità scolpendo e plasmando la pietra, hanno creato borghi medioevali di incantevole ed eterna bellezza. Conservando questo saper fare e la passione per la pietra, abbiamo investito in ricerca e tecnologia, offrendo a tutti coloro che la amano, un prodotto unico e di pregio, ricostruendo con le nostre mani la materia che ha dato vita a questo ambiente e quella che darà vita al tuo.

OUR HISTORY

It was in Umbria, in the green heart of Italy, that PIETRE D'ARREDO was born. Here, history, the culture of stone and with it the tradition of building, are the very core of the identity of the craftsmen of the past, who skillfully sculpting and moulding the stone, created our medieval towns of such enchanting and eternal beauty. Preserving this expertise and the passion for stone, we have invested in research and technology to offer a unique and prestigious product, recreating with our own hands the masonry that has given life to these spectacular surroundings and that will do the same for yours.

UNSERE GESCHICHTE

Es ist In Umbrien, im grünen Herzen Italiens, wo PIETRE D'ARREDO entstand. Hier die Geschichte, die Kultur des Steins und damit die Tradition des Bauens, sind die Grundlage der handwerklichen Identität unserer Vorfahren, die mit ihrer Handfertigkeit, den Stein behauend und gestaltend, mittelalterliche Dörfer von bezaubernder und ewiger Schönheit schufen. Wir haben dieses Know-how und diese Liebe zum Stein bewahrt und in Forschung und Technologie investiert, um allen Liebhabern des Steins ein einzigartiges, wertvolles Produkt zu bieten. Wir bilden mit unseren Händen dieselbe Materie nach, die diese Umgebung ins Leben gerufen hat und die dein Ambiente schaffen wird.

NOTRE HISTOIRE

C'est en Ombrie, dans le cœur vert de l'Italie, que la société PIETRE D'ARREDO a été créée. Ici l'histoire, la culture de la pierre et avec elle la tradition de la construction sont à la base de l'identité artisanale de nos ancêtres, qui grâce à leur habileté manuelle, en sculptant et en modelant la pierre, ont construit des bourgs médiévaux au charme ravissant et éternel. En conservant ce savoir-faire et la passion pour la pierre, nous avons investi dans la recherche et la technologie, pour offrir à tous ceux qui l'aiment, un produit unique et de qualité, en reconstruisant de nos propres mains la matière qui a créé ce milieu et celle qui créera le votre.

SVILUPPATO DA COLMEF

Powered by COLMEF | Entwickelt von COLMEF | Développé par COLMEF



LA NOSTRA FILOSOFIA

Colmef, con i suoi 40 anni di esperienza nel settore dei prodotti per l'edilizia, è una delle poche aziende al mondo che implementa in autonomia tutte le fasi della filiera produttiva: dalla selezione della pietra per la realizzazione delle matrici e degli stampi, fino alla produzione della pietra stessa, degli adesivi e degli stucchi. Colmef attraverso il brand Pietre d'Arredo sostiene la mission di Green Building Council Italia, a dimostrazione del continuo impegno a sviluppare sistemi e prodotti che contribuiscono al rispetto dell'ambiente: "trasformare il mercato dell'edilizia promuovendo progettazione, costruzione e gestione di edifici che siano sostenibili dal punto di vista ambientale, sociale, economico e della salute". L'innovativa tecnica di produzione consente di ridurre al minimo gli sfridi e la fedeltà della definizione delle superfici rendono i nostri manufatti un perfetto sostituto della pietra naturale, limitandone il prelievo in cava, a rispetto e tutela dell'ambiente. La nostra pietra ricostruita protegge il sistema di involucro edilizio dagli agenti atmosferici, integra i sistemi di isolamento termico migliorando il comfort abitativo e, per la sua leggerezza, facilita le operazioni di posa.

OUR PHILOSOPHY

COLMEF, with its 40 years of experience in the area of special products for the building industry, is one of the few companies worldwide that implements autonomously all stages of the production chain, from the selection of the stone for the realization of dies and moulds, up to the production of the stone itself, of the adhesives, of the grouts and of all the products required for the treatment. "Transforming the construction market by promoting the design, construction and management of buildings that are sustainable in terms of the environment, society, economy and health". Through the brand Pietre d'Arredo, COLMEF supports the mission of Green Building Council Italia, demonstrating continued commitment to developing products and systems for environmental protection. The innovative manufacturing technique allows for minimum waste and the accurate definition of surfaces makes it a perfect substitute for natural stone, limiting extraction from the quarry, thus respecting and protecting the environment. It protects the building enclosure from weather conditions and fortifies thermal insulation systems, thus improving living comfort. It facilitates application because of its light weight.

UNSERE PHILOSOPHIE

COLMEF, mit seinen 40 Jahren Erfahrung im Bereich der Spezialprodukte für die Bauindustrie, ist eines der wenigen Unternehmen weltweit, das selbstständig alle Stufen der Produktionskette implementiert, von der Auswahl des Steins für die Realisierung von Matrizen und Formen, bis zur Herstellung des Steins, der Klebstoffe, der Fugenmörteln und der notwendigen Produkte für die Behandlung. "Eine Umgestaltung des Baumarktes durch die Förderung von Planung, Konstruktion und Verwaltung von nachhaltigen Gebäuden aus umwelttechnischer, sozialer, wirtschaftlicher und gesundheitlicher Sicht". Durch die Marke Pietre d'Arredo unterstützt Colmef die Mission des Green Building Council Italia und stellt damit sein kontinuierliches Engagement für die Entwicklung von Systemen und Produkten im Zeichen des Umweltschutzes unter Beweis. Das innovative Herstellungsverfahren reduziert Abfall auf ein Minimum. Durch die natürliche Optik der Oberflächen ist das Produkt ein perfekter Ersatz für Naturstein. So muss weniger Stein in Steinbrüchen abgebaut werden und die Umwelt wird geschützt. Das Material schützt die Gebäudehülle vor Witterungseinflüssen und verbessert die Wärmedämmung und somit den Wohnkomfort. Es ist besonders einfach zu verlegen. Beim Verlegen empfehlen wir die Steine aus verschiedenen Kartons zu mischen, um ein natürliches Aussehen und eine farblich einheitliche Oberfläche zu erzielen.

NOTRE PHILOSOPHIE

Colmef, avec ses 40 ans d'expérience dans le secteur des produits spéciaux pour le bâtiment, est parmi les rares entreprises au monde qui mettent en œuvre en autonomie toutes les phases de la filière productive, à partir de la sélection de la pierre pour la réalisation des matrices et des moules, jusqu'à la production de la pierre, des adhésifs, des joints et de tous produits nécessaires pour le traitement. "Transformer le marché du bâtiment à travers la promotion de la conception, la construction et la gestion d'édifices durables du point de vue écologique, social, économique et de la santé". À travers la marque Pietre d'Arredo, Colmef soutient la mission de Green Building Council Italia, prouvant ainsi son engagement continu dans le développement de systèmes et de produits qui contribuent au respect de l'environnement. La technique de production innovante permet de réduire au minimum les rebuts et grâce à la fidélité de la définition des surfaces, cette ligne représente un substitut parfait de la pierre naturelle, en limitant son extraction en carrière, pour le respect et la protection de l'environnement. Elle protège le système d'enveloppe du bâtiment contre les agents atmosphériques, intègre les systèmes d'isolement thermique en améliorant le confort résidentiel. Grâce à sa légèreté, les opérations de pose sont très simples.

GARANZIA

Warranty | Garantie | Garantie



SISTEMA INTEGRATO

Integrated System | Integriertes System | Système intégré



Gli elementi di finitura PIETRE D'ARREDO vengono forniti in un unico sistema integrato con prodotti studiati e creati appositamente per la realizzazione di un'opera realistica, tecnicamente valida ed efficiente che prevede l'utilizzo dell'adesivo rasante ARREDOCOLLA, il rivestimento in pietra o mattoni ricostruiti PIETRE D'ARREDO e la malta naturale per la stuccatura delle fughe ARREDOSTUCCO.

PIETRE D'ARREDO finishing elements are supplied in a sole integrated system with products specifically designed and manufactured to provide a realistic, technically valid and efficient piece of work that includes the use of the smoothing adhesive ARREDOCOLLA, the PIETRE D'ARREDO reconstructed stone facing and the natural mortar for grouting ARREDOSTUCCO.

Die Elemente PIETRE D'ARREDO werden in Form eines Integrierten Systems geliefert, mit Produkten die speziell für die Erstellung einer realistischen Arbeit entwickelt und hergestellt wurden, technischer hochstand und effizient diese beinhaltet die Verwendung des ARREDOCOLLA unser Kleber der für das Glätten geeignet ist, die Kunststeine oder Kunstziegeln Verblendungen PIETRE D'ARREDO und die natürliche Mörtel ARREDOSTUCCO für die Spachtelung der Fugen.

Les éléments de finition PIETRE D'ARREDO sont fournis dans un système unique intégré avec des produits étudiés et créés spécialement pour la réalisation d'un ouvrage réaliste, techniquement valide et efficace qui prévoit l'emploi de l'adhésif enduit ARREDOCOLLA, le revêtement en pierre ou briques reconstitués PIETRE D'ARREDO et le mortier naturel pour le jointoiment des joints ARREDOSTUCCO.

STANDARD EUROPEI

European Standard | Europäischen Standards | Normes européennes

Le caratteristiche tecniche delle nostre pietre sono state determinate nel rispetto delle seguenti normative europee:

The technical features of our veneer elements have been determined according to the following European standards:

Die technischen Merkmale von unseren Kunststeine wurden nach den folgenden Europäischen Standards bestimmt:

Les caractéristiques techniques de nos pierres reconstituées ont été déterminées sur la base des normes européennes suivantes:

UNI EN 14617-1

Determinazione della massa volumica apparente e dell'assorbimento d'acqua | Determination of the apparent density and water absorption | Bestimmung der Rohdichte und Wasseraufnahme | Détermination de la masse volumique apparente et de l'absorption d'eau

UNI EN 14617-15

Determinazione della resistenza a compressione | Determination of compressive strength
Bestimmung der Druckfestigkeit | Détermination de la résistance à la compression

UNI EN 14617-2

Determinazione della resistenza a flessione | Determination of flexural strength
Bestimmung der Druck- und Biegefestigkeit | Détermination de la résistance à la flexion

UNI EN 14617-5

Determinazione della resistenza al gelo e al disgelo e della resistenza a flessione dopo i cicli di gelo e disgelo
Determination of freeze and thaw resistance and flexural strength after freeze-thaw cycles
Bestimmung der Frost- und Tauwasserbeständigkeit und der Biegefestigkeit nach Frost- und Tauwetterzyklen
Détermination de la résistance au gel et au dégel et de la résistance à la flexion après les cycles de gel et dégel

UNI EN 14617-6

Determinazione della resistenza agli sbalzi termici e della resistenza a flessione dopo gli sbalzi termici
Determination of thermal shock resistance and flexural strength after thermal shocks
Bestimmung der Temperaturwechselbeständigkeit und Biegefestigkeit nach thermischen Veränderungen
Détermination de la résistance aux chocs thermiques et de la résistance à la flexion après les chocs thermiques

UNI EN 14617-11

Determinazione del coefficiente di dilatazione termica | Determination of the thermal expansion coefficient
Bestimmung des thermischen Ausdehnungskoeffizienten | Détermination du coefficient de dilatation thermique

UNI EN 14617-12

Determinazione della stabilità dimensionale | Determination of dimensional stability
Bestimmung der Maßhaltigkeit | Détermination de la stabilité dimensionnelle

UNI EN 1745

Determinazione sperimentale della conducibilità termica | Experimental determination of thermal conductivity
Experimentelle Bestimmung der Wärmeleitfähigkeit | Détermination expérimentale de la conductivité thermique

UNI EN ISO 16000-9:2006; ISO 16000-6:2011; Decreto Francese n.2011-321 del 23/03/2011 e delibera del 19/04/2011

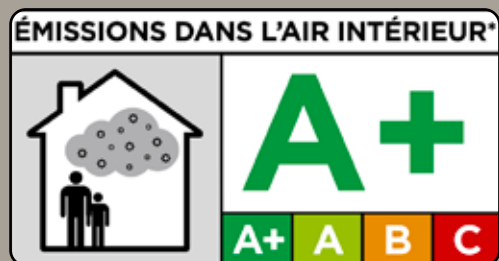

Ci prendiamo cura del tuo respiro. La pietra ricostruita Pietre d'Arredo è a bassissima emissione di COV (composti organici volatili).

We care your breath. The reconstructed stone of Pietre d'Arredo has very VOC (volatile organic compounds) low emission.

Wir lieben deinen Atem. Der rekonstruierte Stein ist mit sehr geringer VOC-Emission (flüchtige organische Trägerstoffe).

Nous prenons soin de votre souffle. La pierre reconstituée Pietre d'Arredo est à très faible émission de COV (composés organiques volatils).

PROCESSO DI ASCIUGATURA E FISSAGGIO DEL COLORE

Drying process and colour setting

Trocknungsprozess und Farb Fixierung

Procès de séchage et fixage de la couleur

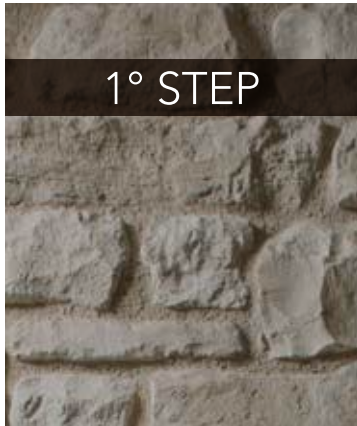

1° STEP

UN PROCESSO NATURALE

La nostra pietra viene prodotta e successivamente imballata ancora umida in scatole di cartone e per questo motivo, all'arrivo in cantiere, potrebbe risultare di tonalità leggermente più scura rispetto a quella scelta. Il naturale lento processo di asciugatura garantisce elevate caratteristiche meccaniche al prodotto e fissa stabilmente il colore in superficie. Una volta applicata in parete, con l'esposizione all'aria, la pietra raggiungerà la sua tonalità definitiva. La nostra pietra viene colorata artigianalmente, è possibile quindi una tonalità leggermente diversa tra i vari lotti di produzione. È consigliabile, pertanto, ordinare in un'unica fornitura tutto il materiale necessario alla realizzazione del lavoro e miscelare la pietra prelevando gli elementi da diverse scatole, in modo da ottenere una superficie con effetto cromatico omogeneo.

A NATURAL PROCESS

Our veneer stone is produced, and then packed, still wet in cardboard boxes and for this reason, when arriving at the building site, it may be in a slightly darker shade compared to the one chosen. The natural slow drying process ensures high mechanical features to the product and fixes permanently the colour on its surface. Once applied onto the wall, thanks to the air exposure, the veneer stone will reach its final shade. As our veneer stone is handcrafted, a slightly different shade between the various production lots is possible. We therefore recommend ordering the whole quantity necessary to complete the installation in a single supply and mix the veneer stones by taking the elements from several boxes, so as to achieve a homogeneous chromatic effect.



2° STEP

ANWENDUNGSPROZESS

Das Material wird produziert und noch feucht, in die Kartons verpackt deshalb könnte die Farbe in einem ersten Moment einen Ton dunkler wirken als die die Sie ausgesucht haben. Der Trocknungsprozess geht auf natürliche Art weiter, und zwar vor und nach der Verlegung des Produkts, und so wird der Farbton dank Einwirkung von Luft nach und nach ausgeglichen. Unser Kunststein wird handwerklich angestrichen deshalb ist es ratsam, das notwendige Material für die Verkleidung eines Bereichs in einer einzigen Lieferung zu bestellen und dann den Inhalt der Kartons zu mischen, so dass man einen homogenen Effekt bekommt.

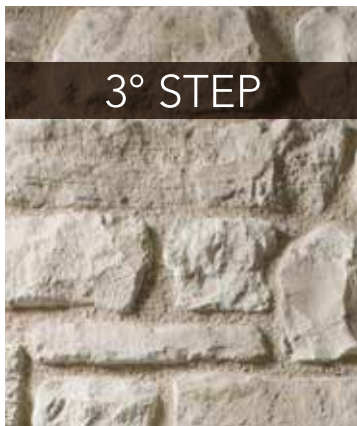

3° STEP

UN PROCÈS NATUREL

Notre pierre est produite et ensuite emballée encore humide dans boîtes de carton et pour ce motif, à l'arrivage sur chantier, peut résulter de tonalité légèrement plus foncée par rapport à celle choisie. Le naturel long processus de séchage garantit hautes caractéristiques mécaniques au produit et fixe de manière stable la couleur sur la surface. Une fois appliquée sur le mur, avec l'exposition à l'air, la pierre obtiendra sa tonalité définitive. Notre pierre est colorée artisanalement, il est donc possible une tonalité légèrement différente entre les divers lots de production. Il est ainsi conseillé de commander en une seule livraison tout le matériel nécessaire pour la réalisation du travail et mélanger la pierre en prenant les éléments de boîtes différentes, de manière à obtenir une surface avec effet chromatique homogène.

ORDINARE LA GIUSTA QUANTITÀ

How to order the right quantity

Die richtige Menge bestellen

Commandez la quantité correcte

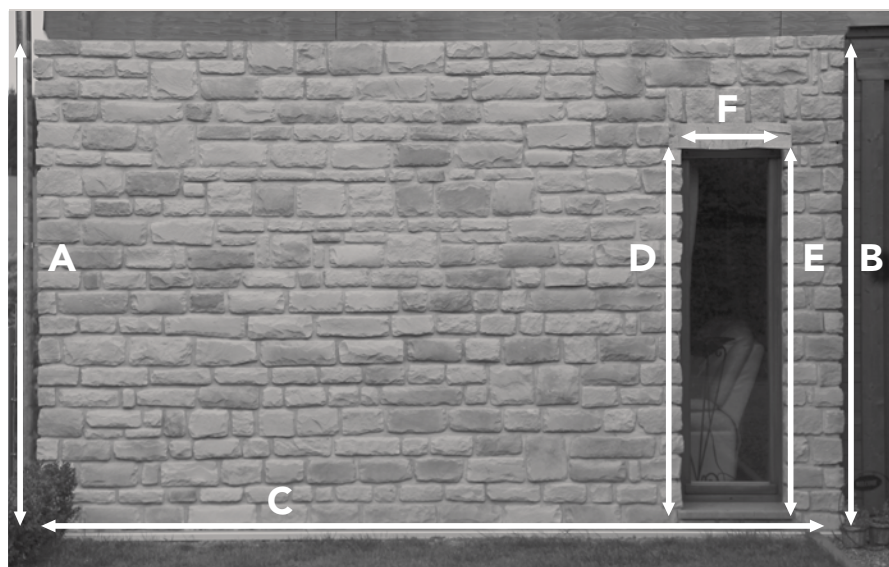

ELEMENTI ANGOLARI
CORNER ELEMENTS
ECKELEMENTE
ÉLÉMENTS D'ANGLE

$$A + B + D + E = m_{\text{tot.}}$$

ELEMENTI PIANI
FLAT ELEMENTS
FLACHE ELEMENTE
ÉLÉMENTS PLATS

$$(A \times C) - (m_{\text{tot.}} \times 0,25) - (D \times F) = m_{\text{tot.}}$$

Arrotondare i quantitativi a scatola intera.

Round up the quantities to full boxes.

Die Mengen auf ein Karton aufrunden.

Arrondir les quantités à la boîte entière.

Computo

Tutti i modelli sono forniti in elementi piani ed elementi angolari. I modelli si distinguono in: FUGATI, posati con fuga; NON FUGATI, posati a secco senza fuga. I modelli FUGATI sono confezionati considerando l'ampiezza della fuga tra gli elementi. Alcuni dei modelli FUGATI possono essere posati anche a secco, a seconda del gusto personale: in questo caso, considerare sempre un 15% in più di materiale necessario rispetto alla metratura conteggiata. In base al modello, considerare sempre una piccola quantità di materiale in più per compensare eventuali sfridi o da utilizzare per i tagli.

Calculation

All models are supplied in flat and corner elements. The models are divided into: GROUTED, when laid with joint; DRY-STACKED, when laid without joint. GROUTED models are packed considering the width of the joint between elements. Some of the GROUTED models can also be dry laid, depending on personal taste: in this case, the quantity of stone ordered should be increased by 15%. Depending on the model, always consider a small amount of extra material to compensate for any scraps or to be used for cuts.

Berechnung

Alle Modelle werden in als flache Elemente und als Eckelemente geliefert. Die Modelle sind unterteilt in: VERFUGTE, für Verlegung mit Fugen; NICHT VERFUGTE, für Trockenverlegung ohne Fugen. Die VERFUGTEN Modelle sind auch unter Berücksichtigung der Breite der Fuge zwischen den Elementen verpackt. Einige der VERFUGTEN Modelle können je nach dem persönlichen Geschmack auch trocken verlegt werden: In diesem Fall muss berücksichtigt werden, dass immer etwa 15% mehr Material notwendig ist, als bei der berechneten Menge. Je nach dem Modell muss auch eine geringe Menge zusätzliches Material miteinberechnet werden, um eventuell entstehenden Abfall auszugleichen oder wenn Schnitte ausgeführt werden müssen.

Calcul

Tous les modèles sont fournis en éléments plats et éléments d'angles. Les modèles se distinguent en: JOINTÉS, posés avec joint; NON JOINTÉS, posés à sec sans joint. Les modèles JOINTÉS sont conditionnés en considérant la largeur du joint entre les éléments. Certains modèles JOINTÉS peuvent être posés également à sec, selon le goût personnel: dans ce cas, il faut toujours considérer 15 % en plus de matériel nécessaire par rapport aux quantités calculées. En fonction du modèle, il faut toujours considérer une petite quantité de matériel en plus pour compenser les éventuels rebuts ou à utiliser pour les coupes.



la tradizione

tradition | Die Tradition | la tradition

Pietred'Arredo[®]
naturalmente ricostruite



ARENAL



BIANCO TERRA

ARREDOCOLLA:
ARREDOSTUCCO:

GRIGIO
PERLA / AVORIO



CREMA

ARREDOCOLLA:
ARREDOSTUCCO:

GRIGIO
PERLA / AVORIO



GRIGIO LUCE

GRIGIO
GRIGIO / PERLA



GRIGIO ANTICO

GRIGIO
GRIGIO / AVORIO



GRIGIO TERRA

GRIGIO
GRIGIO / PERLA / AVORIO



SABBIA

ARREDOCOLLA:
ARREDOSTUCCO:

GRIGIO
AVORIO



TERRA

GRIGIO
AVORIO



MARRONE CHIARO

GRIGIO
AVORIO



GRIGIO CHIARO

GRIGIO
GRIGIO / PERLA

SPECIFICHE DI PRODOTTO - PRODUCT SPECIFICATIONS - ANGABEN ZUM PRODUKT - CARACTÉRISTIQUES DU PRODUIT

	CONFEZIONE * PACKAGING PACKUNG BOÎTE	PESO A CONFEZIONE WEIGHT PER BOX GEWICHT/PACKUNG POIDS PAR BOÎTE	SPESSORE THICKNESS DICKE ÉPAISSEUR	POSA INSTALLATION VERLEGUNG POSE	PREZZO PRICE PREIS PRIX
ELEMENTI PIANI FLAT ELEMENTS FLACHE ELEMENTE ÉLÉMENTS PLATS	1,00 m ² (30,00 m ² /pallet)	≈ 34,00 kg (34,00 kg/m ²)	2,00-4,00 cm	fugato grouted mit Fuge avec joint	114,20 €/m²
ELEMENTI ANGOLARI CORNER ELEMENTS ECKELEMENTE ÉLÉMENTS D'ANGLE	2,00 m (60,00 m/pallet)	≈ 24,00 kg	2,00-4,00 cm		73,20 €/m

RESA-YIELD-VERBRAUCH-RENDEMENT:

ARREDOCOLLA 6-7 kg/m² - ARREDOSTUCCO 8-10 kg/m²

* giunto compreso - joint included - einschließlich Fuge - joint compris ± 5%

GRANADA

BIANCO TERRA

GRIGIO

 ARREDOCOLLA:
ARREDOSTUCCO:

PERLA / AVORIO

CREMA

GRIGIO

PERLA / AVORIO

GRIGIO LUCE

GRIGIO

GRIGIO / PERLA

GRIGIO ANTICO

GRIGIO

GRIGIO / AVORIO

GRIGIO TERRA

GRIGIO

 ARREDOCOLLA:
ARREDOSTUCCO:

GRIGIO / PERLA / AVORIO

TERRA

GRIGIO

AVORIO

GRIGIO CHIARO

GRIGIO

GRIGIO / PERLA

BLU ANTICO

GRIGIO

GRIGIO / GRIGIO SCURO

SPECIFICHE DI PRODOTTO - PRODUCT SPECIFICATIONS - ANGABEN ZUM PRODUKT - CARACTÉRISTIQUES DU PRODUIT

	CONFEZIONE PACKAGING * PACKUNG BOÎTE	PESO A CONFEZIONE WEIGHT PER BOX GEWICHT/PACKUNG POIDS PAR BOÎTE	SPESSORE THICKNESS DICKE ÉPAISSEUR	POSA INSTALLATION VERLEGUNG POSE	PREZZO PRICE PREIS PRIX
ELEMENTI PIANI FLAT ELEMENTS FLACHE ELEMENTE ÉLÉMENTS PLATS	1,00 m ² (30,00 m ² /pallet)	≈ 34,00 kg (34,00 kg/m ²)	2,00-4,00 cm	fugato grouted mit Fuge avec joint	115,80 €/m²
ELEMENTI ANGOLARI CORNER ELEMENTS ECKELEMENTE ÉLÉMENTS D'ANGLE	2,00 m (60,00 m/pallet)	≈ 24,00 kg	2,00-4,00 cm		73,20 €/m

RESA-YIELD-VERBRAUCH-RENDEMENT:

 ARREDOCOLLA 6-7 kg/m² - ARREDOSTUCCO 8-10 kg/m²

* giunto compreso - joint included - einschließlich Fuge - joint compris ± 5%

SANTIAGO



GRIGIO ANTICO

ARREDOCOLLA: GRIGIO
ARREDOSTUCCO: GRIGIO / AVORIO



BIANCO

ARREDOCOLLA: GRIGIO
ARREDOSTUCCO: PERLA



GRIGIO TERRA

ARREDOCOLLA: GRIGIO
ARREDOSTUCCO: GRIGIO / PERLA / AVORIO



TERRA

ARREDOCOLLA: GRIGIO
ARREDOSTUCCO: AVORIO



MARRONE SCURO

ARREDOCOLLA: GRIGIO
ARREDOSTUCCO: AVORIO



ROSATO

ARREDOCOLLA: GRIGIO
ARREDOSTUCCO: PERLA / AVORIO



GRIGIO CHIARO

ARREDOCOLLA: GRIGIO
ARREDOSTUCCO: GRIGIO / PERLA



BLU ANTICO

ARREDOCOLLA: GRIGIO
ARREDOSTUCCO: GRIGIO / GRIGIO SCURO

SPECIFICHE DI PRODOTTO - PRODUCT SPECIFICATIONS - ANGABEN ZUM PRODUKT - CARACTÉRISTIQUES DU PRODUIT

	CONFEZIONE * PACKAGING PACKUNG BOÎTE	PESO A CONFEZIONE WEIGHT PER BOX GEWICHT/PACKUNG POIDS PAR BOÎTE	SPESSORE THICKNESS DICKE ÉPAISSEUR	POSA INSTALLATION VERLEGUNG POSE	PREZZO PRICE PREIS PRIX
ELEMENTI PIANI FLAT ELEMENTS FLACHE ELEMENTE ÉLÉMENTS PLATS	0,80 m ² (24,00 m ² /pallet)	≈ 35,00 kg (43,00 kg/m ²)	4,00-5,00 cm	fugato grouted mit Fuge avec joint	117,30 €/m²
ELEMENTI ANGOLARI CORNER ELEMENTS ECKELEMENTE ÉLÉMENTS D'ANGLE	1,50 m (45,00 m/pallet)	≈ 23,00 kg	4,00-5,00 cm		73,20 €/m

RESA-YIELD-VERBRAUCH-RENDEMENT:

ARREDOCOLLA 6-7 kg/m² - ARREDOSTUCCO 8-10 kg/m²

* giunto compreso - joint included - einschließlich Fuge - joint compris ± 5%

TEIDE

BIANCO TERRA

 ARREDOCOLLA:
ARREDOSTUCCO:

 GRIGIO
PERLA / AVORIO

BIANCO

 GRIGIO
PERLA / AVORIO

GRIGIO TERRA

 GRIGIO
GRIGIO / PERLA / AVORIO

TERRA

 ARREDOCOLLA:
ARREDOSTUCCO:

 GRIGIO
AVORIO

GRIGIO CHIARO

 GRIGIO
GRIGIO / PERLA

SPECIFICHE DI PRODOTTO - PRODUCT SPECIFICATIONS - ANGABEN ZUM PRODUKT - CARACTÉRISTIQUES DU PRODUIT

	CONFEZIONE * PACKAGING PACKUNG BOÎTE	PESO A CONFEZIONE WEIGHT PER BOX GEWICHT/PACKUNG POIDS PAR BOÎTE	SPESSORE THICKNESS DICKE ÉPAISSEUR	POSA INSTALLATION VERLEGUNG POSE	PREZZO PRICE PREIS PRIX
ELEMENTI PIANI FLAT ELEMENTS FLACHE ELEMENTE ÉLÉMENTS PLATS	0,80 m ² (24,00 m ² /pallet)	≈ 32,00 kg (43,00 kg/m ²)	2,50-5,00 cm	fugato grouted mit Fuge avec joint	117,30 €/m²
ELEMENTI ANGOLARI CORNER ELEMENTS ECKELEMENTE ÉLÉMENTS D'ANGLE	1,00 m (30,00 m/pallet)	≈ 16,00 kg	2,50-5,00 cm		73,20 €/m

RESA-YIELD-VERBRAUCH-RENDEMENT:

 ARREDOCOLLA 6-7 kg/m² - ARREDOSTUCCO 10-12 kg/m²

* giunto compreso - joint included - einschließlich Fuge - joint compris ± 5%

JAVA



BIANCO

ARREDOCOLLA: GRIGIO
ARREDOSTUCCO: PERLA / AVORIO



GRIGIO TERRA

ARREDOCOLLA: GRIGIO
ARREDOSTUCCO: GRIGIO / PERLA / AVORIO



TERRA

ARREDOCOLLA: GRIGIO
ARREDOSTUCCO: AVORIO



GRIGIO CHIARO

ARREDOCOLLA: GRIGIO
ARREDOSTUCCO: GRIGIO / PERLA

SPECIFICHE DI PRODOTTO - PRODUCT SPECIFICATIONS - ANGABEN ZUM PRODUKT - CARACTÉRISTIQUES DU PRODUIT

	CONFEZIONE * PACKAGING PACKUNG BOÎTE	PESO A CONFEZIONE WEIGHT PER BOX GEWICHT/PACKUNG POIDS PAR BOÎTE	SPESSORE THICKNESS DICKE ÉPAISSEUR	POSA INSTALLATION VERLEGUNG POSE	PREZZO PRICE PREIS PRIX
ELEMENTI PIANI FLAT ELEMENTS FLACHE ELEMENTE ÉLÉMENTS PLATS	0,80 m ² (24,00 m ² /pallet)	≈ 34,00 kg (43,00 kg/m ²)	2,50-5,00 cm	fugato grouted mit Fuge avec joint	118,30 €/m²
ELEMENTI ANGOLARI CORNER ELEMENTS ECKELEMENTE ÉLÉMENTS D'ANGLE	1,00 m (30,00 m/pallet)	≈ 18,00 kg	2,50-5,00 cm		73,20 €/m

RESA-YIELD-VERBRAUCH-RENDEMENT:

ARREDOCOLLA 6-7 kg/m² - ARREDOSTUCCO 10-12 kg/m²

* giunto compreso - joint included - einschließlich Fuge - joint compris ± 5%

CERVINO

GRIGIO ANTICO

GRIGIO

GRIGIO / AVORIO

GRIGIO CHIARO

GRIGIO

GRIGIO / PERLA

 ARREDOCOLLA:
 ARREDOSTUCCO:

SPECIFICHE DI PRODOTTO - PRODUCT SPECIFICATIONS - ANGABEN ZUM PRODUKT - CARACTÉRISTIQUES DU PRODUIT					
	CONFEZIONE * PACKAGING PACKUNG BOÎTE	PESO A CONFEZIONE WEIGHT PER BOX GEWICHT/PACKUNG POIDS PAR BOÎTE	SPESSORE THICKNESS DICKE ÉPAISSEUR	POSA INSTALLATION VERLEGUNG POSE	PREZZO PRICE PREIS PRIX
ELEMENTI PIANI FLAT ELEMENTS FLACHE ELEMENTE ÉLÉMENTS PLATS	1,00 m ² (25,00 m ² /pallet)	≈ 40,00 kg (40,00 kg/m ²)	2,50-5,00 cm	fugato / a secco grouted / dry stacked	118,30 €/m²
ELEMENTI ANGOLARI CORNER ELEMENTS ECKELEMENTE ÉLÉMENTS D'ANGLE	2,00 m (50,00 m/pallet)	≈ 28,00 kg	2,50-5,00 cm	mit Fuge / trocken avec joint / joint sec	73,20 €/m
RESA-YIELD-VERBRAUCH-RENDEMENT:			ARREDOCOLLA 6-7 kg/m² - ARREDOSTUCCO 10-12 kg/m²		

Per posa a secco prevedere nell'ordine un quantitativo di pietra maggiorato di ≈ 15%
 For dry stacked installation, the quantity of stone ordered should be increased by ≈ 15%
 Für die Trockenverlegung muss in der Bestellung eine Menge von ≈ 15% zusätzlich vorgesehen werden
 Pour pose à sec, prévoir dans la commande une quantité de pierre majorée de ≈ 15%

* giunto compreso - joint included - einschließlich Fuge - joint compris ± 5%

MADERA



CREMA

ARREDOCOLLA: GRIGIO
ARREDOSTUCCO: PERLA / AVORIO



GRIGIO CHIARO

ARREDOCOLLA: GRIGIO
ARREDOSTUCCO: GRIGIO / PERLA



TERRA

ARREDOCOLLA: GRIGIO
ARREDOSTUCCO: AVORIO

SPECIFICHE DI PRODOTTO - PRODUCT SPECIFICATIONS - ANGABEN ZUM PRODUKT - CARACTÉRISTIQUES DU PRODUIT

	CONFEZIONE * PACKAGING PACKUNG BOÎTE	PESO A CONFEZIONE WEIGHT PER BOX GEWICHT/PACKUNG POIDS PAR BOÎTE	SPESSORE THICKNESS DICKE ÉPAISSEUR	POSA INSTALLATION VERLEGUNG POSE	PREZZO PRICE PREIS PRIX
ELEMENTI PIANI FLAT ELEMENTS FLACHE ELEMENTE ÉLÉMENTS PLATS	0,50 m ² (24,00 m ² /pallet)	≈ 18,00 kg (36,00 kg/m ²)	2,50-5,00 cm	fugato grouted mit Fuge avec joint	118,30 €/m²
ELEMENTI ANGOLARI CORNER ELEMENTS ECKELEMENTE ÉLÉMENTS D'ANGLE	1,00 m (48,00 m/pallet)	≈ 14,00 kg	2,50-5,00 cm		73,20 €/m

RESA-YIELD-VERBRAUCH-RENDEMENT:

ARREDOCOLLA 6-7 kg/m² - ARREDOSTUCCO 8-10 kg/m²

* giunto compreso - joint included - einschließlich Fuge - joint compris ± 5%

TAOS

BIANCO

 ARREDOCOLLA:
ARREDOSTUCCO:

 GRIGIO
PERLA / AVORIO

BIANCO ANTICO

 GRIGIO
PERLA / AVORIO

MARRONE ANTICO

 GRIGIO
GRIGIO / AVORIO

GRIGIO TERRA

 ARREDOCOLLA:
ARREDOSTUCCO:

 GRIGIO
GRIGIO / PERLA / AVORIO

MARRONE CHIARO

 GRIGIO
AVORIO

SPECIFICHE DI PRODOTTO - PRODUCT SPECIFICATIONS - ANGABEN ZUM PRODUKT - CARACTÉRISTIQUES DU PRODUIT

	CONFEZIONE * PACKAGING PACKUNG BOÎTE	PESO A CONFEZIONE WEIGHT PER BOX GEWICHT/PACKUNG POIDS PAR BOÎTE	SPESSORE THICKNESS DICKE ÉPAISSEUR	POSA INSTALLATION VERLEGUNG POSE	PREZZO PRICE PREIS PRIX
ELEMENTI PIANI FLAT ELEMENTS FLACHE ELEMENTE ÉLÉMENTS PLATS	1,00 m ² (30,00 m ² /pallet)	≈ 35,00 kg (35,00 kg/m ²)	3,00-5,00 cm	fugato grouted mit Fuge avec joint	115,20 €/m²
ELEMENTI ANGOLARI CORNER ELEMENTS ECKELEMENTE ÉLÉMENTS D'ANGLE	2,00 m (60,00 m/pallet)	≈ 33,00 kg	3,00-5,00 cm		73,20 €/m

RESA-YIELD-VERBRAUCH-RENDEMENT:

 ARREDOCOLLA 6-7 kg/m² - ARREDOSTUCCO 8-10 kg/m²

* giunto compreso - joint included - einschließlich Fuge - joint compris ± 5%

VESUVIO



CREMA

GRIGIO

PERLA / AVORIO / OCRA



SABBIA

GRIGIO

AVORIO

ARREDOCOLLA:
ARREDOSTUCCO:

SPECIFICHE DI PRODOTTO - PRODUCT SPECIFICATIONS - ANGABEN ZUM PRODUKT - CARACTÉRISTIQUES DU PRODUIT					
	CONFEZIONE * PACKAGING PACKUNG BOÎTE	PESO A CONFEZIONE WEIGHT PER BOX GEWICHT/PACKUNG POIDS PAR BOÎTE	SPESSORE THICKNESS DICKE ÉPAISSEUR	POSA INSTALLATION VERLEGUNG POSE	PREZZO PRICE PREIS PRIX
ELEMENTI PIANI FLAT ELEMENTS FLACHE ELEMENTE ÉLÉMENTS PLATS	1,60 m ² (24,00 m ² /pallet)	≈ 36,00 kg (23,00 kg/m ²)	≈ 2,00 cm	fugato grouted mit Fuge avec joint	111,70 €/m²
ELEMENTI ANGOLARI CORNER ELEMENTS ECKELEMENTE ÉLÉMENTS D'ANGLE	2,00 m (60,00 m/pallet)	≈ 20,00 kg	≈ 2,00 cm		73,20 €/m
RESA-YIELD-VERBRAUCH-RENDEMENT:			ARREDOCOLLA 6-7 kg/m ² - ARREDOSTUCCO 6-8 kg/m ²		

* giunto compreso - joint included - einschließlich Fuge - joint compris ± 5%

SASSO DI FIUME

CREMA

 ARREDOCOLLA:
ARREDOSTUCCO:

 GRIGIO
PERLA / AVORIO

GRIGIO TERRA

 GRIGIO
GRIGIO / PERLA / AVORIO

GRIGIO MIX

 GRIGIO
GRIGIO / PERLA / AVORIO

CENERE

 ARREDOCOLLA:
ARREDOSTUCCO:

 GRIGIO
GRIGIO / PERLA

SPECIFICHE DI PRODOTTO - PRODUCT SPECIFICATIONS - ANGABEN ZUM PRODUKT - CARACTÉRISTIQUES DU PRODUIT

	CONFEZIONE * PACKAGING PACKUNG BOÎTE	PESO A CONFEZIONE WEIGHT PER BOX GEWICHT/PACKUNG POIDS PAR BOÎTE	SPESSORE THICKNESS DICKE ÉPAISSEUR	POSA INSTALLATION VERLEGUNG POSE	PREZZO PRICE PREIS PRIX
ELEMENTI PIANI FLAT ELEMENTS FLACHE ELEMENTE ÉLÉMENTS PLATS	1,00 m ² (30,00 m ² /pallet)	≈ 34,00 kg (34,00 kg/m ²)	3,00-5,00 cm	fugato grouted mit Fuge avec joint	118,30 €/m²
ELEMENTI ANGOLARI CORNER ELEMENTS ECKELEMENTE ÉLÉMENTS D'ANGLE	2,00 m (60,00 m/pallet)	≈ 15,00 kg	3,00-5,00 cm		73,20 €/m

RESA-YIELD-VERBRAUCH-RENDEMENT:

 ARREDOCOLLA 6-7 kg/m² - ARREDOSTUCCO 10-12 kg/m²

* giunto compreso - joint included - einschließlich Fuge - joint compris ± 5%

LOKON



GRIGIO TERRA

ARREDOCOLLA: GRIGIO
ARREDOSTUCCO: GRIGIO / PERLA / AVORIO



GRIGIO ANTICO

GRIGIO
GRIGIO / AVORIO



GRIGIO CHIARO

GRIGIO
GRIGIO



MARRONE CHIARO

ARREDOCOLLA: MARRONE CHIARO
ARREDOSTUCCO: AVORIO



ANTRACITE**

GRIGIO
GRIGIO SCURO

SPECIFICHE DI PRODOTTO - PRODUCT SPECIFICATIONS - ANGABEN ZUM PRODUKT - CARACTÉRISTIQUES DU PRODUIT

	CONFEZIONE * PACKAGING PACKUNG BOÎTE	PESO A CONFEZIONE WEIGHT PER BOX GEWICHT/PACKUNG POIDS PAR BOÎTE	SPESSORE THICKNESS DICKE ÉPAISSEUR	POSA INSTALLATION VERLEGUNG POSE	PREZZO PRICE PREIS PRIX
ELEMENTI PIANI FLAT ELEMENTS FLACHE ELEMENTE ÉLÉMENTS PLATS	0,80 m ² (24,00 m ² /pallet)	≈ 36,00 kg (45,00 kg/m ²)	2,00-6,50 cm	fugato grouted mit Fuge avec joint	118,30 €/m²
					**ANTRACITE 123,50 €/m²
ELEMENTI ANGOLARI CORNER ELEMENTS ECKELEMENTE ÉLÉMENTS D'ANGLE	1,50 m (37,50 m/pallet)	≈ 20,00 kg	2,00-6,50 cm		73,20 €/m

RESA-YIELD-VERBRAUCH-RENDEMENT:

ARREDOCOLLA 6-7 kg/m² - ARREDOSTUCCO 8-10 kg/m²

* giunto compreso - joint included - einschließlich Fuge - joint compris ± 5%

OLKARIA

CREMA

CREMA

PERLA

 ARREDOCOLLA:
ARREDOSTUCCO:

GRIGIO TERRA

GRIGIO

GRIGIO / PERLA / AVORIO

GRIGIO ANTICO

GRIGIO

GRIGIO / AVORIO

TERRA

MARRONE CHIARO

AVORIO

GRIGIO CHIARO

GRIGIO

GRIGIO

 ARREDOCOLLA:
ARREDOSTUCCO:

GRIGIO

GRIGIO

GRIGIO

GRIGIO MIX

GRIGIO

GRIGIO

ANTRACITE**

GRIGIO

GRIGIO SCURO

SPECIFICHE DI PRODOTTO - PRODUCT SPECIFICATIONS - ANGABEN ZUM PRODUKT - CARACTÉRISTIQUES DU PRODUIT

	CONFEZIONE * PACKAGING PACKUNG BOÎTE	PESO A CONFEZIONE WEIGHT PER BOX GEWICHT/PACKUNG POIDS PAR BOÎTE	SPESSORE THICKNESS DICKE ÉPAISSEUR	POSA INSTALLATION VERLEGUNG POSE	PREZZO PRICE PREIS PRIX
ELEMENTI PIANI FLAT ELEMENTS FLACHE ELEMENTE ÉLÉMENTS PLATS	0,80 m ² (24,00 m ² /pallet)	≈ 36,00 kg (45,00 kg/m ²)	3,00-6,00 cm	fugato / a secco	118,10 €/m²
				grouted / dry stacked	**ANTRACITE 123,50 €/m²
ELEMENTI ANGOLARI CORNER ELEMENTS ECKELEMENTE ÉLÉMENTS D'ANGLE	1,50 m (45,00 m/pallet)	≈ 20,00 kg	3,00-6,00 cm	mit Fuge / trocken avec joint / joint sec	73,20 €/m

RESA-YIELD-VERBRAUCH-RENDEMENT:
ARREDOCOLLA 6-7 kg/m² - ARREDOSTUCCO 8-10 kg/m²

Per posa a secco prevedere nell'ordine un quantitativo di pietra maggiorato di ≈ 15%
 For dry stacked installation, the quantity of stone ordered should be increased by ≈ 15%
 Für die Trockenverlegung muss in der Bestellung eine Menge von ≈ 15% zusätzlich vorgesehen werden
 Pour pose à sec, prévoir dans la commande une quantité de pierre majorée de ≈ 15%

* giunto compreso - joint included - einschließlich Fuge - joint compris ± 5%

MISTO UMBRO



SABBIA

COMPOSIZIONE
COMPOSITION
MISCHUNG
COMPOSITION

ARENAL sabbia: 70%

ARENAL marrone scuro: 10%

ARENAL grigio terra: 10%

ANTICO MATTONE rosato: 10%

ARREDOCOLLA:
ARREDOSTUCCO:

GRIGIO
AVORIO



GRIGIO TERRA

COMPOSIZIONE
COMPOSITION
MISCHUNG
COMPOSITION

ARENAL grigio terra: 80%

ARENAL grigio chiaro: 10%

ANTICO MATTONE rosato: 10%

GRIGIO
GRIGIO / PERLA / AVORIO



BIANCO TERRA

COMPOSIZIONE
COMPOSITION
MISCHUNG
COMPOSITION

ARENAL bianco terra: 80%

TAOS grigio terra: 10%

ANTICO MATTONE rosato: 10%

GRIGIO
GRIGIO / PERLA / AVORIO



CREMA

COMPOSIZIONE
COMPOSITION
MISCHUNG
COMPOSITION

ARENAL crema: 60%

ARENAL grigio chiaro: 10%

SANTIAGO grigio terra: 20%

TEIDE bianco: 5%

ANTICO MATTONE rosato: 5%

GRIGIO
PERLA / AVORIO

SPECIFICHE DI PRODOTTO - PRODUCT SPECIFICATIONS - ANGABEN ZUM PRODUKT - CARACTÉRISTIQUES DU PRODUIT

	CONFEZIONE * PACKAGING PACKUNG BOÎTE	PESO A CONFEZIONE WEIGHT PER BOX GEWICHT/PACKUNG POIDS PAR BOÎTE	SPESSORE THICKNESS DICKE ÉPAISSEUR	POSA INSTALLATION VERLEGUNG POSE	PREZZO - DA MISCELARE PRICE - TO BE BLENDED PREIS - ZU MISCHEN PRIX - À MÉLANGER	PREZZO - MISCELATO PRICE - READY BLEND PREIS - GEMISCHT PRIX - MÉLANGÉ
ELEMENTI PIANI FLAT ELEMENTS FLACHE ELEMENTE ÉLÉMENTS PLATS	1,00 m ² (25,00 m ² /pallet)	≈ 36,00 kg	2,00-5,00 cm	fugato grouted mit Fuge avec joint	115,00 €/m²	121,60 €/m²
ELEMENTI ANGOLARI CORNER ELEMENTS ECKELEMENTE ÉLÉMENTS D'ANGLE	2,00 m (60,00 m/pallet)	≈ 25,00 kg	2,00-5,00 cm		73,20 €/m	74,20 €/m

RESA-YIELD-VERBRAUCH-RENDEMENT:

ARREDOCOLLA 6-7 kg/m² - ARREDOSTUCCO 8-10 kg/m²

* giunto compreso - joint included - einschließlich Fuge - joint compris ± 5%

MISTO CAMPAGNA

GRIGIO TERRA

COMPOSIZIONE
 COMPOSITION
 MISCHUNG
 COMPOSITION

GRANADA grigio terra: 50%

SANTIAGO grigio terra: 20%

ARENAL crema: 10%

SASSO DI FIUME cenere: 10%

ANTICO MATTONE rosato: 10%

ARREDOCOLLA:
 ARREDOSTUCCO:

GRIGIO
 GRIGIO / PERLA / AVORIO

GRIGIO CHIARO

COMPOSIZIONE
 COMPOSITION
 MISCHUNG
 COMPOSITION

ARENAL grigio chiaro: 45%

ARENAL terra: 5%

SANTIAGO grigio terra: 10%

TEIDE grigio chiaro: 20%

SASSO DI FIUME cenere: 10%

ANTICO MATTONE rosato: 10%

GRIGIO
 GRIGIO / PERLA

CREMA

COMPOSIZIONE
 COMPOSITION
 MISCHUNG
 COMPOSITION

GRANADA crema: 60%

GRANADA grigio chiaro: 10%

SANTIAGO grigio terra: 10%

TEIDE bianco: 5%

SASSO DI FIUME cenere: 5%

ANTICO MATTONE rosato: 10%

GRIGIO
 PERLA / AVORIO

GRIGIO ANTICO

COMPOSIZIONE
 COMPOSITION
 MISCHUNG
 COMPOSITION

ARENAL grigio antico: 60%

ARENAL grigio chiaro: 20%

SASSO DI FIUME cenere: 10%

ANTICO MATTONE rosato: 10%

GRIGIO
 GRIGIO / PERLA / AVORIO

SPECIFICHE DI PRODOTTO - PRODUCT SPECIFICATIONS - ANGABEN ZUM PRODUKT - CARACTÉRISTIQUES DU PRODUIT

	CONFEZIONE * PACKAGING PACKUNG BOÎTE	PESO A CONFEZIONE WEIGHT PER BOX GEWICHT/PACKUNG POIDS PAR BOÎTE	SPESSORE THICKNESS DICKE ÉPAISSEUR	POSA INSTALLATION VERLEGUNG POSE	PREZZO - DA MISCELARE PRICE - TO BE BLENDED PREIS - ZU MISCHEN PRIX - À MÉLANGER	PREZZO - MISCELATO PRICE - READY BLEND PREIS - GEMISCHT PRIX - MÉLANGÉ
ELEMENTI PIANI FLAT ELEMENTS FLACHE ELEMENTE ÉLÉMENTS PLATS	1,00 m ² (25,00 m ² /pallet)	≈ 39,00 kg	2,00-5,00 cm	fugato grouted mit Fuge avec joint	115,00 €/m²	121,60 €/m²
ELEMENTI ANGOLARI CORNER ELEMENTS ECKELEMENTE ÉLÉMENTS D'ANGLE	2,00 m (60,00 m/pallet)	≈ 26,00 kg	2,00-5,00 cm		73,20 €/m	74,20 €/m

RESA-YIELD-VERBRAUCH-RENDEMENT:

ARREDOCOLLA 6-7 kg/m² - ARREDOSTUCCO 8-10 kg/m²

* giunto compreso - joint included - einschließlich Fuge - joint compris ± 5%

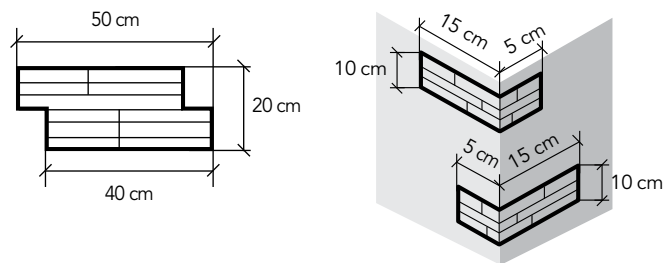

CERVINO PANEL

A SCHEMA DI POSA | LAYING PATTERN ANBAUSCHEMA | SCHÉMA DE POSE

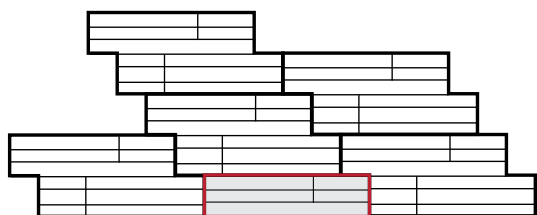

PEZZO SPECIALE | SPECIAL PIECE
SONDERSTÜCK | PIÈCE SPÉCIAL

ARREDOCOLLA:

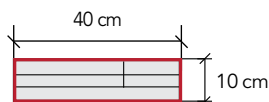

B SCHEMA DI POSA | LAYING PATTERN ANBAUSCHEMA | SCHÉMA DE POSE

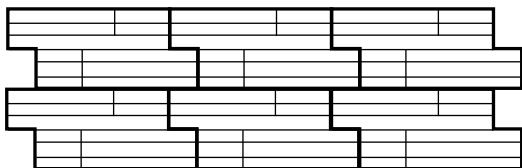

BIANCO ANTICO

CREMA



GRIGIO ANTICO

MARRONE CHIARO



NUVOLA

GRIGIO



MARRONE CHIARO

MARRONE CHIARO



CENERE

GRIGIO

ARREDOCOLLA:

SPECIFICHE DI PRODOTTO - PRODUCT SPECIFICATIONS - ANGABEN ZUM PRODUKT - CARACTÉRISTIQUES DU PRODUIT

	CONFEZIONE PACKAGING PACKUNG BOÎTE	PESO A CONFEZIONE WEIGHT PER BOX GEWICHT/PACKUNG POIDS PAR BOÎTE	SPESSORE THICKNESS DICKE ÉPAISSEUR	POSA INSTALLATION VERLEGUNG POSE	PREZZO PRICE PREIS PRIX
ELEMENTI PIANI FLAT ELEMENTS FLACHE ELEMENTE ÉLÉMENTS PLATS	0,32 m ² (19,20 m ² /pallet)	≈ 21,00 kg (68,00 kg/m ²)	3,00-6,00 cm	a secco dry stacked trocken joint sec	118,30 €/m²
ELEMENTI ANGOLARI CORNER ELEMENTS ECKELEMENTE ÉLÉMENTS D'ANGLE	1,00 m (60,00 m/pallet)	≈ 25,00 kg	3,00-6,00 cm		73,20 €/m
PEZZO SPECIALE SPECIAL PIECE SONDERSTÜCK PIÈCE SPÉCIAL	0,32 m ² (Nr. 8)	≈ 21,00 kg (68,00 kg/m ²)	3,00-6,00 cm		6,40 €/Nr.

RESA-YIELD-VERBRAUCH-RENDEMENT:

ARREDOCOLLA 6-7 kg/m²

BELMONTE



COMPOSIZIONE COMPOSITION MISCHUNG COMPOSITION

SANTIAGO terra 20%

TEIDE terra 20%

SANTIAGO grigio terra 20%

TEIDE grigio terra 20%

ARENAL marrone scuro 10%

SANTIAGO grigio chiaro 10%

ARREDOCOLLA:

GRIGIO

ARREDOSTUCCO:

GRIGIO / AVORIO

SPECIFICHE DI PRODOTTO - PRODUCT SPECIFICATIONS - ANGABEN ZUM PRODUKT - CARACTÉRISTIQUES DU PRODUIT

	CONFEZIONE * PACKAGING PACKUNG BOÎTE	PESO A CONFEZIONE WEIGHT PER BOX GEWICHT/PACKUNG POIDS PAR BOÎTE	SPESSORE THICKNESS DICKE ÉPAISSEUR	POSA INSTALLATION VERLEGUNG POSE	PREZZO - MISCELATO PRICE - READY BLEND PREIS - GEMISCHT PRIX - MÉLANGÉ
ELEMENTI PIANI FLAT ELEMENTS FLACHE ELEMENTE ÉLÉMENTS PLATS	1,00 m ² (25,00 m ² /pallet)	≈ 41,00 kg	2,00-5,00 cm	fugato grouted mit Fuge avec joint	121,80 €/m²
ELEMENTI ANGOLARI CORNER ELEMENTS ECKELEMENTE ÉLÉMENTS D'ANGLE	2,00 m (60,00 m/pallet)	≈ 30,00 kg	2,00-5,00 cm		74,20 €/m

RESA-YIELD-VERBRAUCH-RENDEMENT:

ARREDOCOLLA 6-7 kg/m² - ARREDOSTUCCO 8-10 kg/m²

* giunto compreso - joint included - einschließlich Fuge - joint compris ± 5%

BORGONOVO



COMPOSIZIONE
COMPOSITION
MISCHUNG
COMPOSITION

ARENAL grigio chiaro: 40%

ARENAL terra: 10%

ARENAL grigio terra: 20%

ARENAL marrone scuro: 10%

OLKARIA terra: 10%

ANTICO MATTONE rosato: 10%

ARREDOCOLLA:

GRIGIO

ARREDOSTUCCO:

GRIGIO / AVORIO

SPECIFICHE DI PRODOTTO - PRODUCT SPECIFICATIONS - ANGABEN ZUM PRODUKT - CARACTÉRISTIQUES DU PRODUIT

	CONFEZIONE * PACKAGING PACKUNG BOÎTE	PESO A CONFEZIONE WEIGHT PER BOX GEWICHT/PACKUNG POIDS PAR BOÎTE	SPESSORE THICKNESS DICKE ÉPAISSEUR	POSA INSTALLATION VERLEGUNG POSE	PREZZO - MISCELATO PRICE - READY BLEND PREIS - GEMISCHT PRIX - MÉLANGÉ
ELEMENTI PIANI FLAT ELEMENTS FLACHE ELEMENTE ÉLÉMENTS PLATS	1,00 m ² (25,00 m ² /pallet)	≈ 35,00 kg	2,00-5,00 cm	fugato grouted mit Fuge avec joint	121,80 €/m²
ELEMENTI ANGOLARI CORNER ELEMENTS ECKELEMENTE ÉLÉMENTS D'ANGLE	2,00 m (60,00 m/pallet)	≈ 26,00 kg	2,00-5,00 cm		74,20 €/m

RESA-YIELD-VERBRAUCH-RENDEMENT:

ARREDOCOLLA 6-7 kg/m² - ARREDOSTUCCO 8-10 kg/m²

* giunto compreso - joint included - einschließlich Fuge - joint compris ± 5%

CORTEVECCHIO

COMPOSIZIONE
COMPOSITION
MISCHUNG
COMPOSITION

ARENAL grigio terra: 35%

ARENAL terra: 20%

SANTIAGO grigio chiaro: 20%

SANTIAGO marrone scuro: 5%

TEIDE grigio chiaro: 20%

ARREDOCOLLA:

GRIGIO

ARREDOSTUCCO:

GRIGIO / AVORIO

SPECIFICHE DI PRODOTTO - PRODUCT SPECIFICATIONS - ANGABEN ZUM PRODUKT - CARACTÉRISTIQUES DU PRODUIT

	CONFEZIONE * PACKAGING PACKUNG BOÎTE	PESO A CONFEZIONE WEIGHT PER BOX GEWICHT/PACKUNG POIDS PAR BOÎTE	SPESSORE THICKNESS DICKE ÉPAISSEUR	POSA INSTALLATION VERLEGUNG POSE	PREZZO - MISCELATO PRICE - READY BLEND PREIS - GEMISCHT PRIX - MÉLANGÉ
ELEMENTI PIANI FLAT ELEMENTS FLACHE ELEMENTE ÉLÉMENTS PLATS	1,00 m ² (25,00 m ² /pallet)	≈ 33,00 kg	2,00-5,00 cm	fugato grouted mit Fuge avec joint	121,80 €/m²
ELEMENTI ANGOLARI CORNER ELEMENTS ECKELEMENTE ÉLÉMENTS D'ANGLE	2,00 m (60,00 m/pallet)	≈ 24,00 kg	2,00-5,00 cm		74,20 €/m

RESA-YIELD-VERBRAUCH-RENDEMENT:

ARREDOCOLLA 6-7 kg/m² - ARREDOSTUCCO 8-10 kg/m²

* giunto compreso - joint included - einschließlich Fuge - joint compris ± 5%

CORTONA

 COMPOSIZIONE
 COMPOSITION
 MISCHUNG
 COMPOSITION

ARENAL sabbia: 30%

TEIDE grigio chiaro: 45%

TEIDE grigio terra: 20%

ANTICO MATTONE arancio: 2%

ANTICO MATTONE rosato: 3%

ARREDOCOLLA: GRIGIO

ARREDOSTUCCO: GRIGIO / AVORIO

SPECIFICHE DI PRODOTTO - PRODUCT SPECIFICATIONS - ANGABEN ZUM PRODUKT - CARACTÉRISTIQUES DU PRODUIT

	CONFEZIONE * PACKAGING PACKUNG BOÎTE	PESO A CONFEZIONE WEIGHT PER BOX GEWICHT/PACKUNG POIDS PAR BOÎTE	SPESSORE THICKNESS DICKE ÉPAISSEUR	POSA INSTALLATION VERLEGUNG POSE	PREZZO - MISCELATO PRICE - READY BLEND PREIS - GEMISCHT PRIX - MÉLANGÉ
ELEMENTI PIANI FLAT ELEMENTS FLACHE ELEMENTE ÉLÉMENTS PLATS	1,00 m ² (25,00 m ² /pallet)	≅ 34,00 kg	2,00-5,00 cm	fugato grouted mit Fuge avec joint	121,80 €/m²
ELEMENTI ANGOLARI CORNER ELEMENTS ECKELEMENTE ÉLÉMENTS D'ANGLE	2,00 m (60,00 m/pallet)	≅ 24,00 kg	2,00-5,00 cm		74,20 €/m

RESA-YIELD-VERBRAUCH-RENDEMENT:

ARREDOCOLLA 6-7 kg/m² - ARREDOSTUCCO 8-10 kg/m²

* giunto compreso - joint included - einschließlich Fuge - joint compris ± 5%

TOSCANO



TERRA

COMPOSIZIONE
COMPOSITION
MISCHUNG
COMPOSITION

ARENAL terra: 50%

ARENAL sabbia: 20%

ARENAL marrone scuro: 15%

ANTICO MATTONE rosato: 10%

SASSO DI FIUME cenere: 5%

ARREDOCOLLA:
ARREDOSTUCCO:

GRIGIO
AVORIO

SPECIFICHE DI PRODOTTO - PRODUCT SPECIFICATIONS - ANGABEN ZUM PRODUKT - CARACTÉRISTIQUES DU PRODUIT

	CONFEZIONE * PACKAGING PACKUNG BOÎTE	PESO A CONFEZIONE WEIGHT PER BOX GEWICHT/PACKUNG POIDS PAR BOÎTE	SPESSORE THICKNESS DICKE ÉPAISSEUR	POSA INSTALLATION VERLEGUNG POSE	PREZZO - MISCELATO PRICE - READY BLEND PREIS - GEMISCHT PRIX - MÉLANGÉ
ELEMENTI PIANI FLAT ELEMENTS FLACHE ELEMENTE ÉLÉMENTS PLATS	1,00 m ² (25,00 m ² /pallet)	≈ 34,00 kg	2,00-5,00 cm	fugato grouted mit Fuge avec joint	121,80 €/m²
ELEMENTI ANGOLARI CORNER ELEMENTS ECKELEMENTE ÉLÉMENTS D'ANGLE	2,00 m (60,00 m/pallet)	≈ 24,00 kg	2,00-5,00 cm		74,20 €/m

RESA-YIELD-VERBRAUCH-RENDEMENT:

ARREDOCOLLA 6-7 kg/m² - ARREDOSTUCCO 8-10 kg/m²

* giunto compreso - joint included - einschließlich Fuge - joint compris ± 5%

ETRUSCO



TERRA

COMPOSIZIONE
COMPOSITION
MISCHUNG
COMPOSITION

ARENAL terra: 40%

ARENAL grigio terra: 10%

ARENAL marrone scuro: 10%

TEIDE terra: 30%

SASSO DI FIUME cenere: 3%

ANTICO MATTONE rosso: 2%

ANTICO MATTONE rosato: 5%

ARREDOCOLLA:

GRIGIO

ARREDOSTUCCO:

AVORIO

SPECIFICHE DI PRODOTTO - PRODUCT SPECIFICATIONS - ANGABEN ZUM PRODUKT - CARACTÉRISTIQUES DU PRODUIT

	CONFEZIONE * PACKAGING PACKUNG BOÎTE	PESO A CONFEZIONE WEIGHT PER BOX GEWICHT/PACKUNG POIDS PAR BOÎTE	SPESSORE THICKNESS DICKE ÉPAISSEUR	POSA INSTALLATION VERLEGUNG POSE	PREZZO - MISCELATO PRICE - READY BLEND PREIS - GEMISCHT PRIX - MÉLANGÉ
ELEMENTI PIANI FLAT ELEMENTS FLACHE ELEMENTE ÉLÉMENTS PLATS	1,00 m ² (25,00 m ² /pallet)	≈ 35,00 kg	2,50-5,00 cm	fugato grouted mit Fuge avec joint	121,80 €/m²
ELEMENTI ANGOLARI CORNER ELEMENTS ECKELEMENTE ÉLÉMENTS D'ANGLE	2,00 m (60,00 m/pallet)	≈ 26,00 kg	2,50-5,00 cm		74,20 €/m

RESA-YIELD-VERBRAUCH-RENDEMENT:

ARREDOCOLLA 6-7 kg/m² - ARREDOSTUCCO 8-10 kg/m²

* giunto compreso - joint included - einschließlich Fuge - joint compris ± 5%

ALPINO

GRIGIO CHIARO

COMPOSIZIONE
 COMPOSITION
 MISCHUNG
 COMPOSITION

TEIDE grigio chiaro: 60%

ARENAL grigio chiaro: 20%

SANTIAGO grigio chiaro: 20%

TERRA

COMPOSIZIONE
 COMPOSITION
 MISCHUNG
 COMPOSITION

MADERA grigio chiaro: 25%

TEIDE terra: 25%

SANTIAGO marrone scuro: 15%

SANTIAGO grigio chiaro: 15%

ARENAL terra: 10%

LOKON marrone chiaro: 10%

ARREDOCOLLA:
 ARREDOSTUCCO:

GRIGIO
 GRIGIO

GRIGIO
 AVORIO

SPECIFICHE DI PRODOTTO - PRODUCT SPECIFICATIONS - ANGABEN ZUM PRODUKT - CARACTÉRISTIQUES DU PRODUIT

	CONFEZIONE * PACKAGING PACKUNG BOÎTE	PESO A CONFEZIONE WEIGHT PER BOX GEWICHT/PACKUNG POIDS PAR BOÎTE	SPESSORE THICKNESS DICKE ÉPAISSEUR	POSA INSTALLATION VERLEGUNG POSE	PREZZO - MISCELATO PRICE - READY BLEND PREIS - GEMISCHT PRIX - MÉLANGÉ
ELEMENTI PIANI FLAT ELEMENTS FLACHE ELEMENTE ÉLÉMENTS PLATS	1,00 m ² (25,00 m ² /pallet)	≈ 40,00 kg	2,00-6,50 cm	fugato grouted mit Fuge avec joint	121,80 €/m²
ELEMENTI ANGOLARI CORNER ELEMENTS ECKELEMENTE ÉLÉMENTS D'ANGLE	2,00 m (60,00 m/pallet)	≈ 30,00 kg	2,00-6,50 cm		74,20 €/m

RESA-YIELD-VERBRAUCH-RENDEMENT:

ARREDOCOLLA 6-7 kg/m² - ARREDOSTUCCO 8-10 kg/m²

* giunto compreso - joint included - einschließlich Fuge - joint compris ± 5%

MONTANO



GRIGIO TERRA

COMPOSIZIONE
COMPOSITION
MISCHUNG
COMPOSITION

SANTIAGO grigio terra: 40%

SANTIAGO grigio chiaro: 10%

ARENAL grigio terra: 20%

ARENAL grigio antico: 10%

TEIDE grigio terra: 20%

ARREDOCOLLA:
ARREDOSTUCCO:

GRIGIO

GRIGIO / PERLA



GRIGIO CHIARO

COMPOSIZIONE
COMPOSITION
MISCHUNG
COMPOSITION

SANTIAGO grigio chiaro: 40%

SANTIAGO grigio terra: 10%

TEIDE grigio: 20%

TEIDE grigio chiaro: 20%

ARENAL marrone scuro: 10%

GRIGIO

GRIGIO

SPECIFICHE DI PRODOTTO - PRODUCT SPECIFICATIONS - ANGABEN ZUM PRODUKT - CARACTÉRISTIQUES DU PRODUIT					
	CONFEZIONE * PACKAGING PACKUNG BOÎTE	PESO A CONFEZIONE WEIGHT PER BOX GEWICHT/PACKUNG POIDS PAR BOÎTE	SPESSORE THICKNESS DICKE ÉPAISSEUR	POSA INSTALLATION VERLEGUNG POSE	PREZZO - MISCELATO PRICE - READY BLEND PREIS - GEMISCHT PRIX - MÉLANGÉ
ELEMENTI PIANI FLAT ELEMENTS FLACHE ELEMENTE ÉLÉMENTS PLATS	1,00 m ² (25,00 m ² /pallet)	≈ 41,00 kg	2,00-5,00 cm	fugato grouted mit Fuge avec joint	121,80 €/m²
ELEMENTI ANGOLARI CORNER ELEMENTS ECKELEMENTE ÉLÉMENTS D'ANGLE	2,00 m (60,00 m/pallet)	≈ 30,00 kg	2,00-5,00 cm		74,20 €/m
RESA-YIELD-VERBRAUCH-RENDEMENT:			ARREDOCOLLA 6-7 kg/m ² - ARREDOSTUCCO 8-10 kg/m ²		

* giunto compreso - joint included - einschließlich Fuge - joint compris ± 5%

TIROLESE

GRIGIO ANTICO

COMPOSIZIONE
 COMPOSITION
 MISCHUNG
 COMPOSITION

TEIDE grigio chiaro: 60%

SANTIAGO grigio antico: 40%

TERRA

COMPOSIZIONE
 COMPOSITION
 MISCHUNG
 COMPOSITION

TEIDE grigio terra: 40%

TEIDE terra: 30%

MADERA terra: 30%

GRIGIO

COMPOSIZIONE
 COMPOSITION
 MISCHUNG
 COMPOSITION

TEIDE grigio chiaro: 40%

TEIDE grigio: 30%

MADERA grigio chiaro: 30%

ARREDOCOLLA:
 ARREDOSTUCCO:

GRIGIO
 GRIGIO / AVORIO

GRIGIO
 AVORIO

GRIGIO
 GRIGIO

SPECIFICHE DI PRODOTTO - PRODUCT SPECIFICATIONS - ANGABEN ZUM PRODUKT - CARACTÉRISTIQUES DU PRODUIT

	CONFEZIONE * PACKAGING PACKUNG BOÎTE	PESO A CONFEZIONE WEIGHT PER BOX GEWICHT/PACKUNG POIDS PAR BOÎTE	SPESSORE THICKNESS DICKE ÉPAISSEUR	POSA INSTALLATION VERLEGUNG POSE	PREZZO - MISCELATO PRICE - READY BLEND PREIS - GEMISCHT PRIX - MÉLANGÉ
ELEMENTI PIANI FLAT ELEMENTS FLACHE ELEMENTE ÉLÉMENTS PLATS	1,00 m ² (25,00 m ² /pallet)	≈ 40,00 kg	2,50-5,00 cm	fugato grouted mit Fuge avec joint	121,80 €/m²
ELEMENTI ANGOLARI CORNER ELEMENTS ECKELEMENTE ÉLÉMENTS D'ANGLE	2,00 m (60,00 m/pallet)	≈ 30,00 kg	2,50-5,00 cm		74,20 €/m

RESA-YIELD-VERBRAUCH-RENDEMENT:

ARREDOCOLLA 6-7 kg/m² - ARREDOSTUCCO 8-10 kg/m²

* giunto compreso - joint included - einschließlich Fuge - joint compris ± 5%

DOLOMITE



MARRONE CHIARO

COMPOSIZIONE
COMPOSITION
MISCHUNG
COMPOSITION

SANTIAGO grigio terra: 40%

LOKON marrone chiaro: 30%

MADERA terra: 30%



GRIGIO CHIARO

COMPOSIZIONE
COMPOSITION
MISCHUNG
COMPOSITION

SANTIAGO grigio: 40%

LOKON grigio chiaro: 30%

MADERA grigio chiaro: 30%

ARREDOCOLLA:
ARREDOSTUCCO:

GRIGIO
AVORIO

GRIGIO
GRIGIO / AVORIO

SPECIFICHE DI PRODOTTO - PRODUCT SPECIFICATIONS - ANGABEN ZUM PRODUKT - CARACTÉRISTIQUES DU PRODUIT

	CONFEZIONE * PACKAGING PACKUNG BOÎTE	PESO A CONFEZIONE WEIGHT PER BOX GEWICHT/PACKUNG POIDS PAR BOÎTE	SPESSORE THICKNESS DICKE ÉPAISSEUR	POSA INSTALLATION VERLEGUNG POSE	PREZZO - MISCELATO PRICE - READY BLEND PREIS - GEMISCHT PRIX - MÉLANGÉ
ELEMENTI PIANI FLAT ELEMENTS FLACHE ELEMENTE ÉLÉMENTS PLATS	1,00 m ² (25,00 m ² /pallet)	≈ 40,00 kg	2,00-6,50 cm	fugato grouted mit Fuge avec joint	121,80 €/m²
ELEMENTI ANGOLARI CORNER ELEMENTS ECKELEMENTE ÉLÉMENTS D'ANGLE	2,00 m (60,00 m/pallet)	≈ 30,00 kg	2,00-6,50 cm		74,20 €/m

RESA-YIELD-VERBRAUCH-RENDEMENT:

ARREDOCOLLA 6-7 kg/m² - ARREDOSTUCCO 10-12 kg/m²

* giunto compreso - joint included - einschließlich Fuge - joint compris ± 5%

VENETO



CREMA

COMPOSIZIONE
COMPOSITION
MISCHUNG
COMPOSITION

ARENAL crema: 60%

ARENAL grigio terra: 5%

TEIDE grigio terra: 25%

SANTIAGO grigio terra: 10%

ARREDOCOLLA:
ARREDOSTUCCO:

GRIGIO
PERLA / AVORIO

SPECIFICHE DI PRODOTTO - PRODUCT SPECIFICATIONS - ANGABEN ZUM PRODUKT - CARACTÉRISTIQUES DU PRODUIT

	CONFEZIONE * PACKAGING PACKUNG BOÎTE	PESO A CONFEZIONE WEIGHT PER BOX GEWICHT/PACKUNG POIDS PAR BOÎTE	SPESSORE THICKNESS DICKE ÉPAISSEUR	POSA INSTALLATION VERLEGUNG POSE	PREZZO - MISCELATO PRICE - READY BLEND PREIS - GEMISCHT PRIX - MÉLANGÉ
ELEMENTI PIANI FLAT ELEMENTS FLACHE ELEMENTE ÉLÉMENTS PLATS	1,00 m ² (25,00 m ² /pallet)	≈ 35,00 kg	2,00-5,00 cm	fugato grouted mit Fuge avec joint	121,80 €/m²
ELEMENTI ANGOLARI CORNER ELEMENTS ECKELEMENTE ÉLÉMENTS D'ANGLE	2,00 m (60,00 m/pallet)	≈ 26,00 kg	2,00-5,00 cm		74,20 €/m

RESA-YIELD-VERBRAUCH-RENDEMENT:

ARREDOCOLLA 6-7 kg/m² - ARREDOSTUCCO 8-10 kg/m²

* giunto compreso - joint included - einschließlich Fuge - joint compris ± 5%

CANOVA



GRIGIO TERRA

COMPOSIZIONE
COMPOSITION
MISCHUNG
COMPOSITION

TEIDE grigio terra: 60%

ARENAL grigio terra: 33%

ANTICO MATTONE rosato: 7%

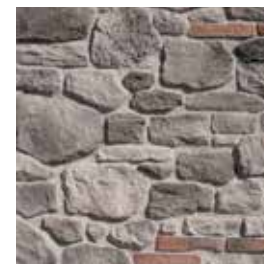

GRIGIO CHIARO

COMPOSIZIONE
COMPOSITION
MISCHUNG
COMPOSITION

TEIDE grigio chiaro: 60%

ARENAL grigio chiaro: 33%

ANTICO MATTONE rosato: 7%

ARREDOCOLLA:
ARREDOSTUCCO:

GRIGIO
GRIGIO / PERLA / AVORIO

GRIGIO
GRIGIO

SPECIFICHE DI PRODOTTO - PRODUCT SPECIFICATIONS - ANGABEN ZUM PRODUKT - CARACTÉRISTIQUES DU PRODUIT

	CONFEZIONE * PACKAGING PACKUNG BOÎTE	PESO A CONFEZIONE WEIGHT PER BOX GEWICHT/PACKUNG POIDS PAR BOÎTE	SPESSORE THICKNESS DICKE ÉPAISSEUR	POSA INSTALLATION VERLEGUNG POSE	PREZZO - MISCELATO PRICE - READY BLEND PREIS - GEMISCHT PRIX - MÉLANGÉ
ELEMENTI PIANI FLAT ELEMENTS FLACHE ELEMENTE ÉLÉMENTS PLATS	1,00 m ² (25,00 m ² /pallet)	≈ 37,00 kg	2,50-5,00 cm	fugato grouted mit Fuge avec joint	121,80 €/m²
ELEMENTI ANGOLARI CORNER ELEMENTS ECKELEMENTE ÉLÉMENTS D'ANGLE	2,00 m (60,00 m/pallet)	≈ 30,00 kg	2,50-5,00 cm		74,20 €/m

RESA-YIELD-VERBRAUCH-RENDEMENT:

ARREDOCOLLA 6-7 kg/m² - ARREDOSTUCCO 8-10 kg/m²

* giunto compreso - joint included - einschließlich Fuge - joint compris ± 5%

LIGURE



GRIGIO CHIARO

COMPOSIZIONE
COMPOSITION
MISCHUNG
COMPOSITION

ARENAL grigio antico 10%

LOKON grigio terra 30%

TEIDE grigio chiaro 40%

OLKARIA grigio antico 20%

ARREDOCOLLA:
ARREDOSTUCCO:

GRIGIO
GRIGIO



BLU ANTICO

COMPOSIZIONE
COMPOSITION
MISCHUNG
COMPOSITION

SANTIAGO blu antico 60%

OLKARIA blu antico 20%

TEIDE grigio terra 20%

GRIGIO SCURO
GRIGIO

SPECIFICHE DI PRODOTTO - PRODUCT SPECIFICATIONS - ANGABEN ZUM PRODUKT - CARACTÉRISTIQUES DU PRODUIT

	CONFEZIONE * PACKAGING PACKUNG BOÎTE	PESO A CONFEZIONE WEIGHT PER BOX GEWICHT/PACKUNG POIDS PAR BOÎTE	SPESSORE THICKNESS DICKE ÉPAISSEUR	POSA INSTALLATION VERLEGUNG POSE	PREZZO - MISCELATO PRICE - READY BLEND PREIS - GEMISCHT PRIX - MÉLANGÉ
ELEMENTI PIANI FLAT ELEMENTS FLACHE ELEMENTE ÉLÉMENTS PLATS	1,00 m ² (25,00 m ² /pallet)	≈ 35,00 kg	2,50-6,00 cm	fugato / a secco grouted / dry stacked	122,80 €/m²
ELEMENTI ANGOLARI CORNER ELEMENTS ECKELEMENTE ÉLÉMENTS D'ANGLE	2,00 m (60,00 m/pallet)	≈ 26,00 kg	2,50-6,00 cm	mit Fuge / trocken avec joint / joint sec	74,20 €/m

RESA-YIELD-VERBRAUCH-RENDEMENT:

ARREDOCOLLA 6-7 kg/m² - ARREDOSTUCCO 8-10 kg/m²

Per posa a secco prevedere nell'ordine un quantitativo di pietra maggiorato di ≈ 15%
For dry stacked installation, the quantity of stone ordered should be increased by ≈ 15%
Für die Trockenverlegung muss in der Bestellung eine Menge von ≈ 15% zusätzlich vorgesehen werden
Pour pose à sec, prévoir dans la commande une quantité de pierre majorée de ≈ 15%

* giunto compreso - joint included - einschließlich Fuge - joint compris ± 5%



il mattone

the brick | Der Zigel | le brique

Pietred'Arredo[®]
naturalmente ricostruite



RUSTICO

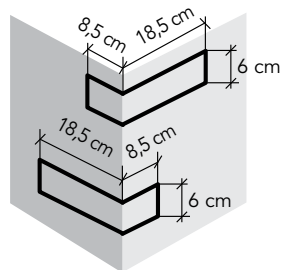
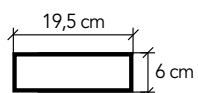

BIANCO **

ARREDOCOLLA:
ARREDOSTUCCO:

GRIGIO
PERLA



ASTER

GRIGIO
GRIGIO / PERLA



IBERIS

GRIGIO
GRIGIO / PERLA



SILENE

ARREDOCOLLA:
ARREDOSTUCCO:

GRIGIO
GRIGIO / PERLA



ANEMONE

GRIGIO
GRIGIO / PERLA



FLOX

GRIGIO
GRIGIO / PERLA

SPECIFICHE DI PRODOTTO - PRODUCT SPECIFICATIONS - ANGABEN ZUM PRODUKT - CARACTÉRISTIQUES DU PRODUIT

	CONFEZIONE * PACKAGING PACKUNG BOÎTE	PESO A CONFEZIONE WEIGHT PER BOX GEWICHT/PACKUNG POIDS PAR BOÎTE	SPESSORE THICKNESS DICKE ÉPAISSEUR	POSA INSTALLATION VERLEGUNG POSE	PREZZO PRICE PREIS PRIX
ELEMENTI PIANI FLAT ELEMENTS FLACHE ELEMENTE ÉLÉMENTS PLATS	1,00 m ² (50,00 m ² /pallet)	≈ 16,00 kg (16,00 kg/m ²)	1,00-1,50 cm	fugato grouted mit Fuge avec joint	96,90 €/m²
	BIANCO** 1,50 m ² (45,00 m ² /pallet)	BIANCO** ≈ 24,00 kg (16,00 kg/m ²)			
ELEMENTI ANGOLARI CORNER ELEMENTS ECKELEMENTE ÉLÉMENTS D'ANGLE	2,00 m (100,00 m/pallet)	≈ 12,50 kg	1,00-1,50 cm		66,00 €/m

RESA-YIELD-VERBRAUCH-RENDMENT:

ARREDOCOLLA 6-7 kg/m² - ARREDOSTUCCO 6-8 kg/m²

* giunto compreso - joint included - einschließlich Fuge - joint compris ± 5%

** per interni - for interiors - für interne - pour interne

ANTICO MATTONI

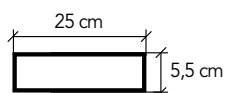

ARREDOCOLLA:
ARREDOSTUCCO:



BIANCO

GRIGIO
GRIGIO / PERLA



CENERE

GRIGIO
GRIGIO / PERLA



GRIGIO FUMO

GRIGIO
GRIGIO / PERLA



GIALLO

GRIGIO
GRIGIO / PERLA / AVORIO

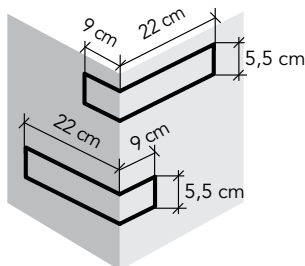

ARREDOCOLLA:
ARREDOSTUCCO:



ARANCIO

GRIGIO
GRIGIO / PERLA / AVORIO



ROSATO

GRIGIO
GRIGIO / PERLA / AVORIO



ROSSO

GRIGIO
GRIGIO / PERLA

SPECIFICHE DI PRODOTTO - PRODUCT SPECIFICATIONS - ANGABEN ZUM PRODUKT - CARACTÉRISTIQUES DU PRODUIT

	CONFEZIONE * PACKAGING PACKUNG BOÎTE	PESO A CONFEZIONE WEIGHT PER BOX GEWICHT/PACKUNG POIDS PAR BOÎTE	SPESSORE THICKNESS DICKE ÉPAISSEUR	POSA INSTALLATION VERLEGUNG POSE	PREZZO PRICE PREIS PRIX
ELEMENTI PIANI FLAT ELEMENTS FLACHE ELEMENTE ÉLÉMENTS PLATS	1,20 m ² (36,00 m ² /pallet)	≈ 38,00 kg (32,00 kg/m ²)	2,50-3,00 cm	fugato grouted mit Fuge avec joint	101,60 €/m²
ELEMENTI ANGOLARI CORNER ELEMENTS ECKELEMENTE ÉLÉMENTS D'ANGLE	2,00 m (60,00 m/pallet)	≈ 22,00 kg	2,50-3,00 cm		69,00 €/m

RESA-YIELD-VERBRAUCH-RENDEMENT:

ARREDOCOLLA 6-7 kg/m² - ARREDOSTUCCO 6-8 kg/m²

* giunto compreso - joint included - einschließlich Fuge - joint compris ± 5%



Il contemporaneo

contemporary | Der Zeitgenosse | le contemporain

Pietred'Arredo®
naturalmente ricostruite



CALEPIO

NEW

Disponibile da Maggio 2024
Available from May 2024
Verfügbar ab Mai 2024
Disponible à partir de Mai 2024



CREMA



BIANCO ANTICO



GRIGIO ANTICO

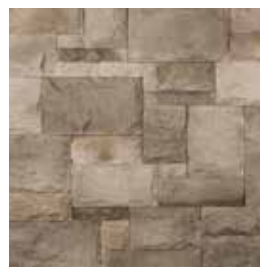

GRIGIO CHIARO

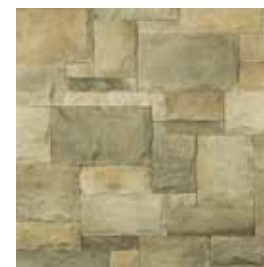

GRIGIO TERRA

SPECIFICHE DI PRODOTTO - PRODUCT SPECIFICATIONS - ANGABEN ZUM PRODUKT - CARACTÉRISTIQUES DU PRODUIT

	CONFEZIONE PACKAGING PACKUNG BOÎTE	PESO A CONFEZIONE WEIGHT PER BOX GEWICHT/PACKUNG POIDS PAR BOÎTE	SPESSORE THICKNESS DICKE ÉPAISSEUR	POSA INSTALLATION VERLEGUNG POSE	PREZZO PRICE PREIS PRIX
ELEMENTI PIANI FLAT ELEMENTS FLACHE ELEMENTE ÉLÉMENTS PLATS	0,88 m ² (22,00 m ² /pallet)	≈ 36,00 kg (40,90 kg/m ²)	≈ 3,00 / 3,50 cm	esclusivamente a secco only dry stacked	114,20 €/m²
ELEMENTI ANGOLARI CORNER ELEMENTS ECKELEMENTE ÉLÉMENTS D'ANGLE	2,00 m (60,00 m/pallet)	≈ 24,00 kg	≈ 3,00 / 3,50 cm	ausschließlich trocken à sec uniquement	73,20 €/m

RESA-YIELD-VERBRAUCH-RENDEMENT:

ARREDOCOLLA 6-7 kg/m²



SAKAR

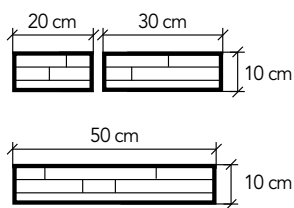

CENERE

GRIGIO



NUVOLA

GRIGIO

ARREDOCOLLA:

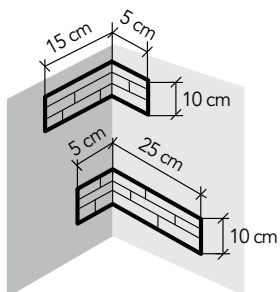

CAMEL

MARRONE CHIARO



GRIGIO FUMO

GRIGIO



BIANCO

CREMA



CREMA

CREMA

ARREDOCOLLA:

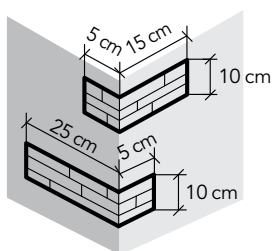

GRIGIO TERRA

GRIGIO



AMBRA

CREMA



GRIGIO CHIARO

GRIGIO



ANTRACITE*

GRIGIO

ARREDOCOLLA:

SPECIFICHE DI PRODOTTO - PRODUCT SPECIFICATIONS - ANGABEN ZUM PRODUKT - CARACTÉRISTIQUES DU PRODUIT

	CONFEZIONE PACKAGING PACKUNG BOÎTE	PESO A CONFEZIONE WEIGHT PER BOX GEWICHT/PACKUNG POIDS PAR BOÎTE	SPESSORE THICKNESS DICKE ÉPAISSEUR	POSA INSTALLATION VERLEGUNG POSE	PREZZO PRICE PREIS PRIX
ELEMENTI PIANI FLAT ELEMENTS FLACHE ELEMENTE ÉLÉMENTS PLATS	0,50 m ² (30,00 m ² /pallet)	≈ 23,00 kg (46,00 kg/m ²)	5,00 cm	a secco dry stacked trocken joint sec	110,70 €/m²
					*ANTRACITE 118,70 €/m²
ANGOLO ESTERNO EXTERNAL CORNER AUSSENECKE ANGLE EXTERNE	1,00 m (60,00 m/pallet)	≈ 15,00 kg	5,00 cm		73,20 €/m
ANGOLO INTERNO INTERNAL CORNER INNENECKE ANGLE INTERNE	1,00 m (60,00 m/pallet)	≈ 15,00 kg	5,00 cm		73,20 €/m

RESA-YIELD-VERBRAUCH-RENDEMENT:

ARREDOCOLLA 6-7 kg/m²

MURIA

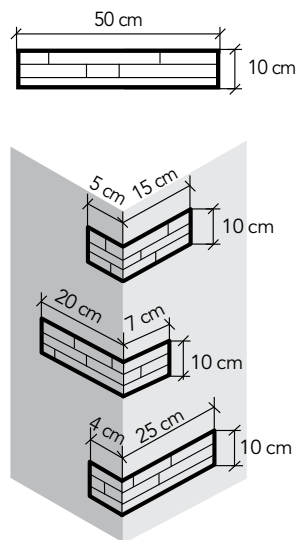

CREMA

ARREDOCOLLA: CREMA



SABBIA

ARREDOCOLLA: CREMA



GRIGIO FUMO

ARREDOCOLLA: GRIGIO



GRIGIO CHIARO

ARREDOCOLLA: GRIGIO

SPECIFICHE DI PRODOTTO - PRODUCT SPECIFICATIONS - ANGABEN ZUM PRODUKT - CARACTÉRISTIQUES DU PRODUIT

	CONFEZIONE PACKAGING PACKUNG BOÎTE	PESO A CONFEZIONE WEIGHT PER BOX GEWICHT/PACKUNG POIDS PAR BOÎTE	SPESSORE THICKNESS DICKE ÉPAISSEUR	POSA INSTALLATION VERLEGUNG POSE	PREZZO PRICE PREIS PRIX
ELEMENTI PIANI FLAT ELEMENTS FLACHE ELEMENTE ÉLÉMENTS PLATS	0,60 m ² (36,00 m ² /pallet)	≈ 22,00 kg (44,00 kg/m ²)	1,00-3,00 cm	a secco dry stacked trocken joint sec	108,00 €/m²
ELEMENTI ANGOLARI CORNER ELEMENTS ECKELEMENTE ÉLÉMENTS D'ANGLE	1,00 m (60,00 m/pallet)	≈ 14,00 kg	1,00-3,00 cm		73,20 €/m

RESA-YIELD-VERBRAUCH-RENDEMENT:

ARREDOCOLLA 6-7 kg/m²



l'effetto legno

wooden effect | Die Holzoptik | l'effet bois

Pietred'Arredo®
naturalmente ricostruite

KALOS

ELEMENTI PIANI | FLAT ELEMENTS FLACHE ELEMENTE | ÉLÉMENTS PLATS

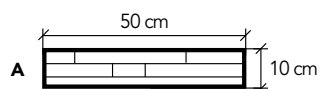

ELEMENTI ANGOLARI | CORNER ELEMENTS ECKELEMENTE | ÉLÉMENTS D'ANGLE

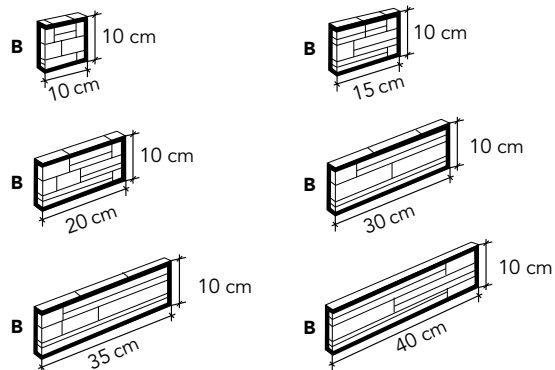

SCHEMA DI POSA | LAYING PATTERN ANBAUSCHEMA | SCHÉMA DE POSE

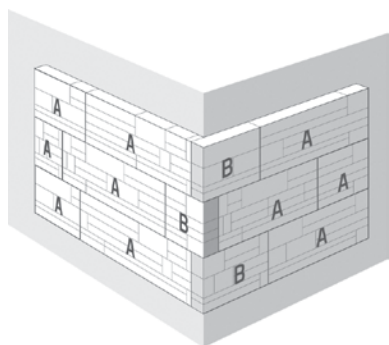

CARAMEL

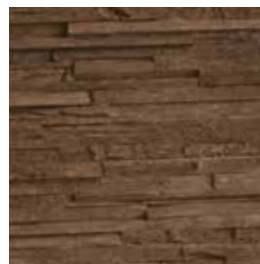

MOKA



CENERE



ROVERE



GRIGIO FUMO



VANILLA

SPECIFICHE DI PRODOTTO - PRODUCT SPECIFICATIONS - ANGABEN ZUM PRODUKT - CARACTÉRISTIQUES DU PRODUIT

	CONFEZIONE PACKAGING PACKUNG BOÎTE	PESO A CONFEZIONE WEIGHT PER BOX GEWICHT/PACKUNG POIDS PAR BOÎTE	SPESSORE THICKNESS DICKE ÉPAISSEUR	POSA INSTALLATION VERLEGUNG POSE	PREZZO PRICE PREIS PRIX
ELEMENTI PIANI FLAT ELEMENTS FLACHE ELEMENTE ÉLÉMENTS PLATS	0,60 m ² (36,00 m ² /pallet)	≈ 18,00 kg (30,00 kg/m ²)	≈ 3,00 cm	a secco dry stacked trocken joint sec	116,20 €/m²
ELEMENTI ANGOLARI CORNER ELEMENTS ECKELEMENTE ÉLÉMENTS D'ANGLE	2,40 m (144,00 m/pallet)	≈ 18,00 kg	≈ 3,00 cm		47,20 €/m

RESA-YIELD-VERBRAUCH-RENDEMENT:

ARREDOCOLLA 6-7 kg/m²

VINTAGE

**ELEMENTI PIANI | FLAT ELEMENTS
FLACHE ELEMENTE | ÉLÉMENTS PLATS**

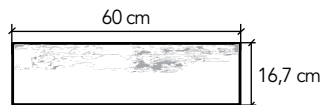

CARAMEL



MOKA



CENERE



VANILLA

SPECIFICHE DI PRODOTTO - PRODUCT SPECIFICATIONS - ANGABEN ZUM PRODUKT - CARACTÉRISTIQUES DU PRODUIT

	CONFEZIONE PACKAGING PACKUNG BOÎTE	PESO A CONFEZIONE WEIGHT PER BOX GEWICHT/PACKUNG POIDS PAR BOÎTE	SPESSORE THICKNESS DICKE ÉPAISSEUR	POSA INSTALLATION VERLEGUNG POSE	COLORE COLOUR FARBE COULEUR	PREZZO PRICE PREIS PRIX
ELEMENTI PIANI FLAT ELEMENTS FLACHE ELEMENTE ÉLÉMENTS PLATS	1,00 m ² (36,00 m ² /pallet)	≈ 32,00 kg (32,00 kg/m ²)	≈ 2,50 cm	a secco dry stacked trocken joint sec	CARAMEL MOKA CENERE VANILLA	115,40 €/m²

RESA-YIELD-VERBRAUCH-RENDEMENT:

ARREDOCOLLA 6-7 kg/m²

VICTORY

ELEMENTI PIANI | FLAT ELEMENTS FLACHE ELEMENTE | ÉLÉMENTS PLATS

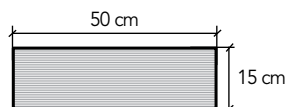

ELEMENTI ANGOLARI | CORNER ELEMENTS ECKELEMENTE | ÉLÉMENTS D'ANGLE

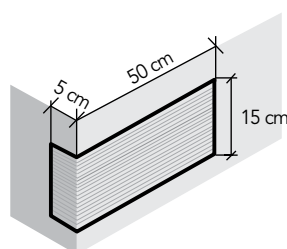

BASIC*

VICTORY BASIC può essere dipinta con qualsiasi tipo di pittura.
 VICTORY BASIC version can be painted with any kind of paint.
 Die Basisversion kann mit jeder Art Farbe gestrichen werden.
 VICTORY BASIC peut être peinte avec n'importe quel type de peinture.

SPECIFICHE DI PRODOTTO - PRODUCT SPECIFICATIONS - ANGABEN ZUM PRODUKT - CARACTÉRISTIQUES DU PRODUIT

	CONFEZIONE PACKAGING PACKUNG BOÎTE	PESO A CONFEZIONE WEIGHT PER BOX GEWICHT/PACKUNG POIDS PAR BOÎTE	SPESSORE THICKNESS DICKE ÉPAISSEUR	POSA INSTALLATION VERLEGUNG POSE	PREZZO PRICE PREIS PRIX
ELEMENTI PIANI FLAT ELEMENTS FLACHE ELEMENTE ÉLÉMENTS PLATS	0,60 m ² (25,20 m ² /pallet)	≈ 19,00 kg (32,00 kg/m ²)	≈ 2,50 cm	a secco dry stacked trocken joint sec	105,10 €/m²
ELEMENTI ANGOLARI CORNER ELEMENTS ECKELEMENTE ÉLÉMENTS D'ANGLE	0,90 m (72,00 m/pallet)	≈ 9,80 kg	≈ 2,50 cm		70,00 €/m

RESA-YIELD-VERBRAUCH-RENDEMENT:

ARREDOCOLLA 6-7 kg/m²

* per interni - for interiors - für Innen - pour interne

MISTO A RICHIESTA

Customized blend

Mischungen auf Wunsch

Mélange sur demande

Misto a richiesta preparato nelle scatole secondo le istruzioni del cliente. Il prezzo rimane invariato indipendentemente dalla composizione e dalla tipologia di pietra.

Customized blend packed in boxes according to the customer requirements. The price will remain steady regardless of stone blend and type.

Mischungen die nach Wunsch des Kunden in den Kartons vorbereitet werden. Der Preis bleibt unverändert unabhängig von der Mischung und von der Serie der Steine.

Mélange sur demande préparé dans les boîtes selon la demande du client. Le prix reste invariable indépendamment de la composition et de la typologie de la pierre.

	PREZZO - MISCELATO PRICE - READY BLEND PREIS - GEMISCHT PRIX - MÉLANGÉ
ELEMENTI PIANI FLAT ELEMENTS FLACHE ELEMENTE ÉLÉMENTS PLATS	128,80 €/m²
ELEMENTI ANGOLARI CORNER ELEMENTS ECKELEMENTE ÉLÉMENTS D'ANGLE	76,30 €/m

A thick, dark brown L-shaped line starts at the top left, goes down, then turns right and goes across the bottom of the page, framing the text.

elementi speciali

special elements | Sonderelemente | éléments particuliers

Pietred'Arredo®
naturalmente ricostruite



SABBIA

ELEMENTO AQVA



SPECIFICHE DI PRODOTTO - PRODUCT SPECIFICATIONS - ANGABEN ZUM PRODUKT - CARACTÉRISTIQUES DU PRODUIT

DIMENSIONI DIMENSIONS ABMESSUNGEN DIMENSIONS	PESO A PEZZO WEIGHT PER PIECE GEWICHT PRO STÜCK POIDS PAR PIECE	PEZZI PER SCATOLA PIECES PER BOX STÜCK/SCHACHTEL PIÈCE PAR BOÎTE	PESO A SCATOLA WEIGHT PER BOX GEWICHT PRO SCHACHTEL POIDS PAR BOÎTE	PREZZO A PEZZO PRICE PER PIECE PREIS/STÜCK PRIX PAR PIÈCE
25,00 x 31,00 cm	≈ 4,70 kg	Nr. 5	24,00 kg	64,00 €

ELEMENTO SAVANA



SABBIA



SPECIFICHE DI PRODOTTO - PRODUCT SPECIFICATIONS - ANGABEN ZUM PRODUKT - CARACTÉRISTIQUES DU PRODUIT

DIMENSIONI DIMENSIONS ABMESSUNGEN DIMENSIONS	PESO A PEZZO WEIGHT PER PIECE GEWICHT PRO STÜCK POIDS PAR PIECE	PEZZI PER SCATOLA PIECES PER BOX STÜCK/SCHACHTEL PIÈCE PAR BOÎTE	PESO A SCATOLA WEIGHT PER BOX GEWICHT PRO SCHACHTEL POIDS PAR BOÎTE	PREZZO A PEZZO PRICE PER PIECE PREIS/STÜCK PRIX PAR PIÈCE
40,00 x 50,00 cm	≈ 18,00 kg	Nr. 1	18,00 kg	117,50 €

KRONOS



BIANCO



GRIGIO TERRA



SABBIA



GRIGIO

SPECIFICHE DI PRODOTTO - PRODUCT SPECIFICATIONS - ANGABEN ZUM PRODUKT - CARACTÉRISTIQUES DU PRODUIT

DIMENSIONI DIMENSIONS ABMESSUNGEN DIMENSIONS	PESO A PEZZO WEIGHT PER PIECE GEWICHT PRO STÜCK POIDS PAR PIÈCE	PEZZI PER SCATOLA PIECES PER BOX STÜCK/SCHACHTEL PIÈCE PAR BOÎTE	PESO A SCATOLA WEIGHT PER BOX GEWICHT PRO SCHACHTEL POIDS PAR BOÎTE	PREZZO A PEZZO PRICE PER PIECE PREIS/STÜCK PRIX PAR PIÈCE
30,00 x 30,00 cm	≈ 11,00 kg	Nr. 1	11,00 kg	107,20 €

TERMINALE

BIANCO



CREMA



GRIGIO TERRA



SABBIA



GRIGIO CHIARO



SPECIFICHE DI PRODOTTO - PRODUCT SPECIFICATIONS - ANGABEN ZUM PRODUKT - CARACTÉRISTIQUES DU PRODUIT

	DIMENSIONE DIMENSION ABMESSUNGEN DIMENSION	PESO A SCATOLA WEIGHT PER BOX GEWICHT/SCHACHTEL POIDS PAR BOÎTE	PESO A PEZZO WEIGHT PER PIECE GEWICHT/STÜCK POIDS PAR PIÈCE	SPESSORE THICKNESS DICKE ÉPAISSEUR	POSA INSTALLATION VERLEGUNG POSE	PREZZO A PEZZO PRICE PER PIECE PREIS/STÜCK PRIX PAR PIÈCE
ELEMENTI PIANI FLAT ELEMENTS FLACHE ELEMENTE ÉLÉMENTS PLATS	50,00 x 7,00 cm	20,00 kg (Nr. 8)	≈ 2,50 kg		fugato grouted mit Fuge avec joint	16,50 €
ELEMENTI ANGOLARI CORNER ELEMENTS ECKELEMENTE ÉLÉMENTS D'ANGLE		27,60 kg (Nr. 12)	≈ 2,30 kg			18,60 €

A thick, dark brown L-shaped line starts at the top left, goes down, then turns right and goes across the bottom of the page, framing the central text.

sistemi innovativi

innovation Systems | innovative systeme | systeme innovants

Pietred'Arredo®
naturalmente ricostruite

A thick, dark brown horizontal line segment located at the bottom right of the page, extending from the right edge towards the left.

AIR SYSTEM

Sistema tecnologico innovativo per la posa di rivestimenti in pietra e mattoni ricostruiti su superfici soggette alla risalita di umidità per capillarità.
Innovative system for the installation of reconstructed stone and brick facings on surfaces subject to capillary moisture rising.

Innovatives System für die Verlegung von Wandbelägen aus Kunststein und Kunstziegeln auf Oberflächen, die feinverteilter Feuchtigkeit unterliegen.
Système innovant pour la pose de revêtements en pierres et briques reconstituées sur surfaces sujettes à la remontée d'humidité par capillarité.

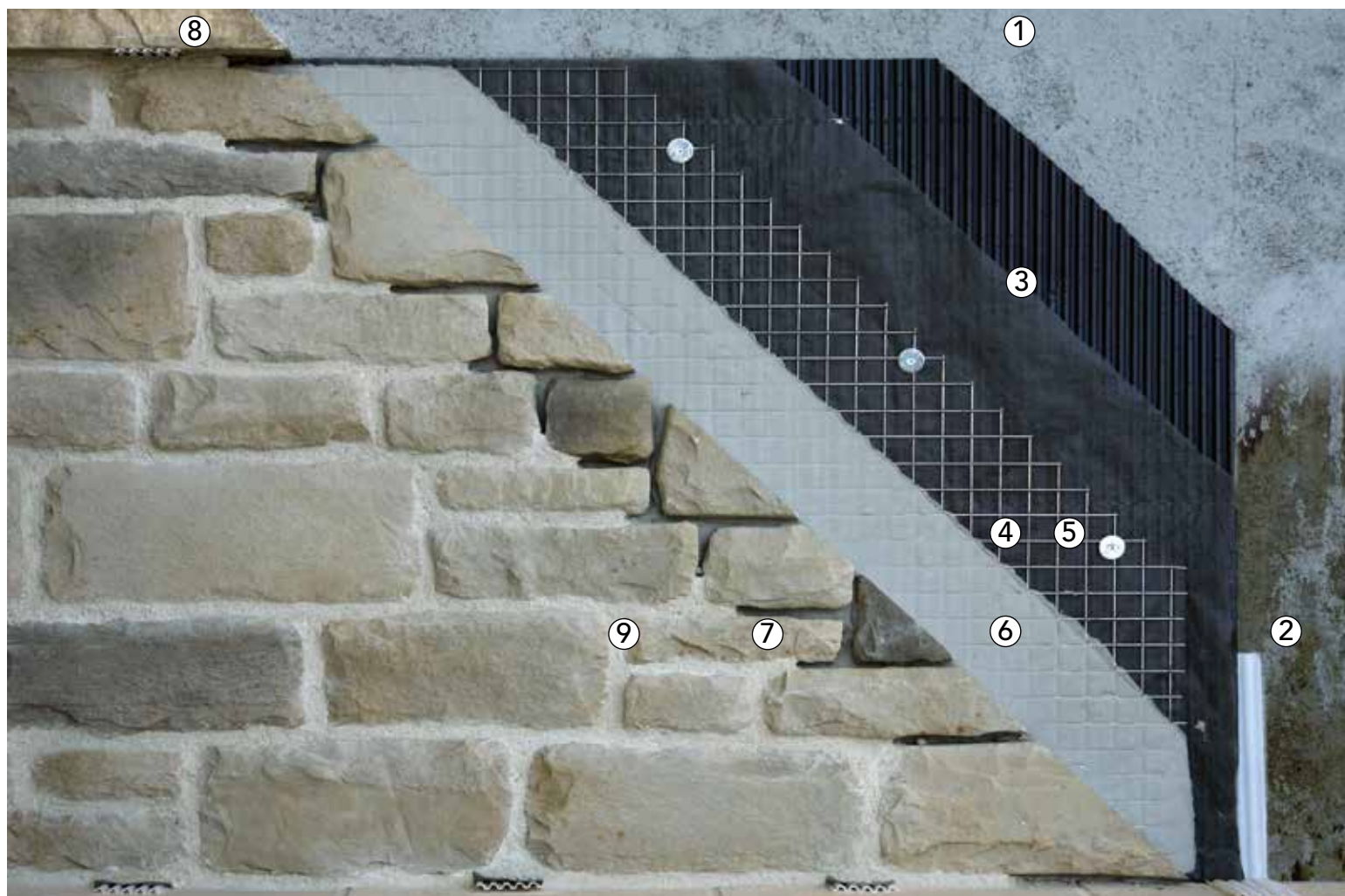

- ① Supporto cementizio
- ② Vento "L"
- ③ Air plast
- ④ Rete zincata
- ⑤ Tasselli di fissaggio
- ⑥ ARREDOCOLLA
- ⑦ PIETRE D'ARREDO
rivestimento in pietra
- ⑧ ricostruita
- ⑨ TERMINALE
ARREDOSTUCCO per il
riempimento e la sigillatura
delle fughe tra gli elementi
del rivestimento

- ① Cementitious substrate
- ② Vento "L"
- ③ Air plast
- ④ Galvanized mesh
- ⑤ Anchor bolts
- ⑥ Arredocollo
- ⑦ Pietre d'arredo
reconstructed stone facings
- ⑧ Terminale
- ⑨ Arredostucco
for the filling and sealing
of the joints between
the coating elements

- ① Betonbelag
- ② Vento "L"
- ③ Air plast
- ④ Verzinktes Gitternetz
- ⑤ Befestigungsdübel
- ⑥ Arredocollo
- ⑦ Pietre d'Arredo
Wandbeläge aus Kunststein
- ⑧ Terminale
- ⑨ Arredostucco für die Füllung
und die Versiegelung
der Fugen zwischen den
Elementen der Verkleidung



- ① Support béton
- ② Vento "L"
- ③ Air plast
- ④ Treillis galvanisé
- ⑤ Boulons d'ancrage
- ⑥ Arredocollo
- ⑦ Pietre d'Arredo parement
en pierre reconstituée
- ⑧ Terminale
- ⑨ Arredostucco
pour le remplissage et le
scellage des joints entre
les éléments du revêtement

Il sistema AIR SYSTEM è composto da: un rotolo di AIR PLAST da 12 m²; 6 fogli da 200 x 100 cm di RETE ZINCATA, maglia 2,5 x 2,5 cm; una scatola di VENTO "L" da 30 pezzi; una scatola di TASSELLI DI FISSAGGIO da 100 pezzi.

AIR SYSTEM consists of: a 12 m² AIR PLAST roll; 6 galvanized mesh sheets 200 x 100 cm with 2,5 x 2,5 cm mesh; a VENTO "L" box, 30 pieces; a box of ANCHOR BOLTS, 100 pieces.

Das AIR SYSTEM besteht aus: einer 12 m² AIR PLAST Rolle; 6 galvanisierte Maschenblätter 200 x 100 cm mit 2,5 x 2,5 cm Maschen; einer Schachtel VENTO "L" mit 30 Stücken; einer Schachtel BEFESTIGUNGSDÜBEL mit 100 Stücken.

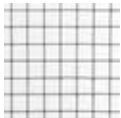
Le système AIR SYSTEM est composé par: un rouleau de AIR PLAST de 12 m²; 6 feuilles 200 x 100 cm de treillis galvanisé avec maille 2,5 x 2,5 cm; une boîte de VENTO "L" de 30 pièces; une boîte de BOULONS D'ANCRAGE de 100 pièces.

		CONFEZIONE PACKAGING PACKUNG EMBALLAGE	PREZZO PRICE PREIS PRIX
	<p>AIR PLAST Prodotto in materiale plastico riciclato a profilo ondulato con passo da 10 mm e altezza da 80 cm. È microfessurato per permettere la ventilazione sia orizzontale che verticale. Preaccoppiato con membrana in polipropilene traspirante idrorepellente. Leggero e facilmente applicabile su qualsiasi supporto.</p> <p>It is a product made of recycled plastic material with corrugated profile, 10 mm pitch and 80 cm height. Its microcracking allows both horizontal and vertical ventilation. Pre-coupled with a membrane made of breathable waterproof polypropylene. It is lightweight and easy to apply on any substrate.</p> <p>Wellenprofil aus wiederverwertetem Kunststoff mit 10 mm Abständen und 80 cm Höhe. Mit Mikrolochung für eine horizontale, als auch vertikale Belüftung. Bereits mit einer transpirierenden und wasserabweisenden Membran aus Polypropylen verbunden. Leicht und einfach auf jeder Unterlage aufzutragen.</p> <p>Fabriqué en plastique recyclé à profil ondulé avec un pas de 10 mm et une hauteur de 80 cm. Ses micro-fentes lui permettent une ventilation autant horizontale que verticale. Pré-couplé avec membrane imperméable transpirante en polypropylène. Léger et facile à appliquer sur n'importe quel support.</p>	12,00 m ² rotolo roll Rolle rouleau	63,90 €/m²
	<p>RETE ZINCATA in fogli da 100 cm di altezza per 200 cm di lunghezza. Rete zincata con maglia 2,5 x 2,5 cm e altezza 100 cm. Serve da supporto per qualsiasi tipo di rivestimento e intonaco.</p> <p>200 x 100 cm GALVANIZED MESH SHEET 2,5 x 2,5 cm galvanized mesh, 100 cm height. It serves as support for any type of coating and plaster.</p> <p>200 x 100 cm GALVANISIERTES MASCHENBLATT Verzinktes Gitternetz mit 2,5 x 2,5 cm Maschen und einer Höhe von 100 cm. Dient als Unterlage für jegliche Verkleidung und jeden Verputz.</p> <p>200 x 100 cm FEUILLE DE TREILLIS GALVANISÉ Treillis galvanisé avec maille 2,5 x 2,5 cm et hauteur de 100 cm. Sert de support à tous types de revêtement et de plâtre.</p>	12,00 m ² foglio sheet Blatt feuille	
	<p>VENTO A "L" Elemento a "elle" realizzato in materiale plastico riciclato a profilo ondulato, da posizionare ogni 25-30 cm dietro AIRPLAST con funzione di alimentare la circolazione dell'aria e drenare l'umidità presente.</p> <p>"L" shaped element made of recycled plastic material with corrugated profile, to be positioned every 25-30 cm behind AIRPLAST to supply the air circulation system and drain the moisture.</p> <p>"L" förmiges Teil mit Wellenprofil aus wiederverwertetem Kunststoff, wird je 25-30 cm hinter dem AIRPLAST platziert und soll für die Luftzirkulation, sowie für die Drainage der Feuchtigkeit sorgen.</p> <p>Élément en "L" en plastique recyclé à profil ondulé, à placer chaque 25-30 cm derrière AIRPLAST en fonction d'alimentation de circulation de l'air et de drainage de l'humidité présente.</p>	Nr. 30 scatola box Schachtel boîte	
	<p>TASSELLI DI FISSAGGIO ø3,5 x 55 mm Tasselli di fissaggio ad espansione, per l'ancoraggio e il sostegno della rete.</p> <p>ANCHOR BOLTS ø3,5 x 55 mm Expansion anchor bolts to anchor and support the mesh.</p> <p>BEFESTIGUNGSDÜBEL ø3,5 x 55 mm Expansionsdübel, zur Verankerung und Halterung des Gitternetzes.</p> <p>BOULONS D'ANCRAGE ø3,5 x 55 mm Boulons d'ancrage à expansion pour l'ancrage et le soutien du treillis.</p>	Nr. 100 scatola box Schachtel boîte	

PIETRA COMFORT

Sistema garantito per la posa di rivestimenti in pietra e mattoni ricostruiti su isolamenti termici esterni di edifici.

High security system for the installation of reconstructed stone and brick facings on external thermal insulation of buildings.

Hochwertiges System für die Verlegung von Wandbelägen aus Kunststein und Kunstziegeln auf Thermoisolierungen bei Gebäudefronten.

Système offrant une garantie élevée pour la pose de revêtements en pierres et briques reconstituées sur isolations thermiques extérieures de bâtiments.

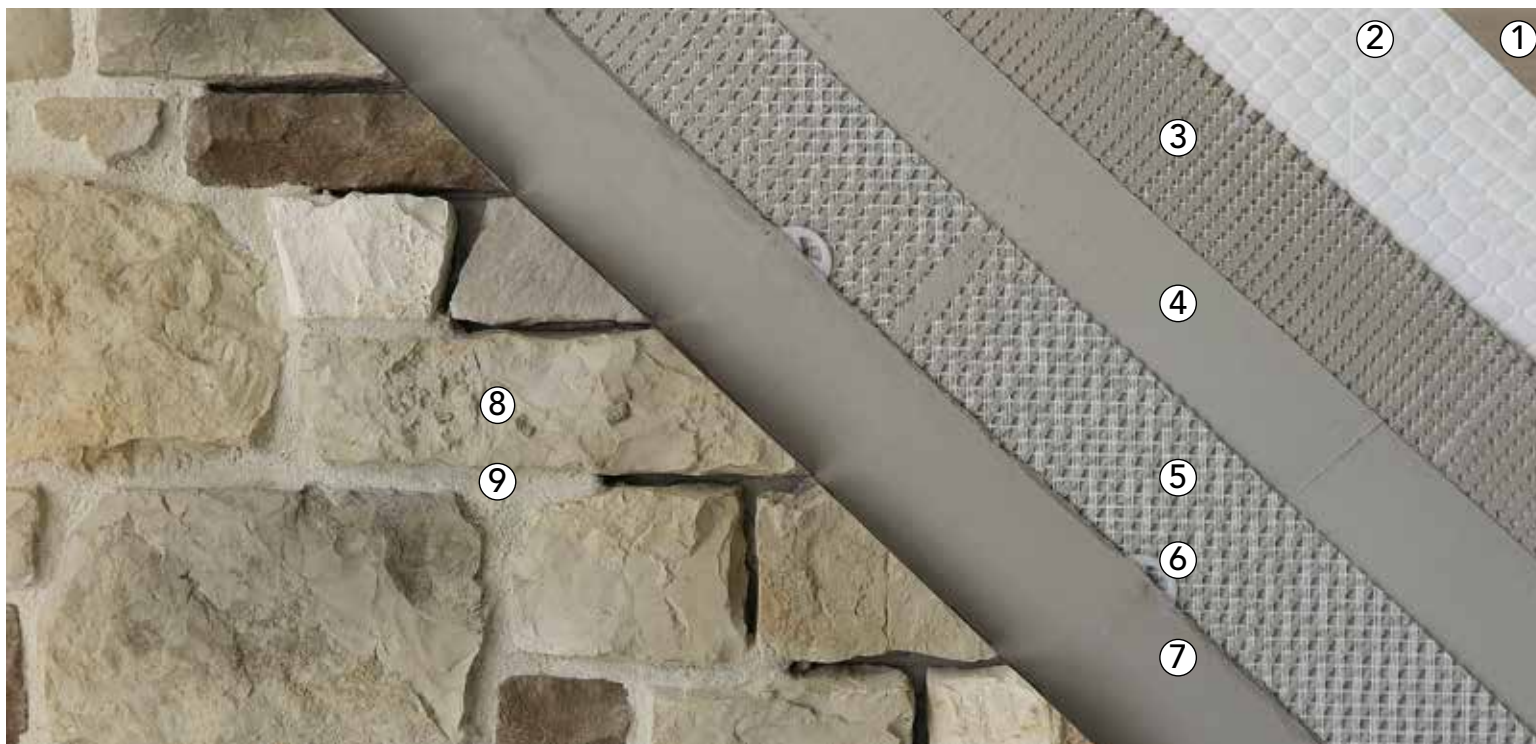

- ① Supporto cementizio
- ② Pannello termoisolante
- ③ Adesivo rasante minerale per la rasatura di pannelli termoisolanti, con interposta armatura in fibra di vetro
- ④ Adesivo rasante minerale per pannelli termoisolanti -2° strato
- ⑤ ARREDOCOLLA adesivo rasante con interposta rete di armatura rinforzata alcali-resistente ARMOFLEX 330
- ⑥ Fissaggio meccanico con tasselli ROCKET
- ⑦ ARREDOCOLLA adesivo rasante-2° strato
- ⑧ PIETRE D'ARREDO rivestimento in pietra ricostruita posato con
- ⑨ ARREDOCOLLA ARREDOSTUCCO + ARREDOLIGHT per il riempimento e la sigillatura delle fughe tra gli elementi del rivestimento

- ① Cementitious substrate
- ② Insulating panel
- ③ Mineral smoothing adhesive for the smoothing of insulating panels, with interposed fibreglass reinforcement
- ④ Mineral smoothing adhesive for insulating panels-2nd layer
- ⑤ ARREDOCOLLA smoothing adhesive, with alkali-resistant interposed reinforcing mesh ARMOFLEX 330
- ⑥ Mechanical fixing with anchors ROCKET
- ⑦ ARREDOCOLLA smoothing adhesive-2nd layer
- ⑧ PIETRE D'ARREDO reconstructed stone facing, laid with ARREDOCOLLA
- ⑨ ARREDOSTUCCO + ARREDOLIGHT for the filling and the sealing of the joints between the coating elements

- ① Betonbelag
- ② Dämmplatte
- ③ Mineralischer Putzkleber für die Glättung von Dämmplatten mit eingebettetem Armiergewebe
- ④ aus Glasfaser Mineralischer Putzkleber für
- ⑤ Dämmplatte-2. Schicht ARREDOCOLLA Putzkleber mit eingebettetem alkaliresistenten Stützgewebe
- ⑥ ARMOFLEX 330 Mechanische Befestigung mit
- ⑦ Dübel ROCKET ARREDOCOLLA Putzkleber
- ⑧ -2.Schicht PIETRE D'ARREDO Wandbelag aus Kunststein
- ⑨ mit ARREDOCOLLA verlegt ARREDOSTUCCO + ARREDOLIGHT für die Füllung und die Versiegelung der Fugen zwischen den Elementen der Verkleidung

- ① Support béton
- ② Panneau isolant
- ③ Colle-enduit minerale de lissage pour le lissage de panneaux isolants, avec armature en fibre de verre
- ④ interposée Colle-enduit minerale de lissage pour panneaux isolants
- ⑤ -2ème couche ARREDOCOLLA colle-enduit de lissage avec une armature renforcée résistante aux alcalis
- ⑥ ARMOFLEX 330 Fixage mécanique avec
- ⑦ ancrage ROCKET ARREDOCOLLA colle-enduit
- ⑧ de lissage-2ème couche PIETRE D'ARREDO parement en pierre reconstituée posé
- ⑨ avec ARREDOCOLLA Arredostucco + Arredolight pour le remplissage et le scellage des joints entre les éléments du revêtement



prodotti tecnici

technical products | technische produkte | produits techniques

Pietred'Arredo[®]
naturalmente ricostruite



ARREDOCOLLA



G2T
EN 12004

25 kg



GRIGIO



CREMA



MARRONE
CHIARO

Adesivo rasante professionale in polvere a base di leganti minerali, ad elevate prestazioni, scivolamento verticale nullo, per la posa di pietre e mattoni ricostruiti. Resa: 6-7 kg/m² a seconda del tipo di supporto.

High performance professional smoothing adhesive composed of mineral binders, no vertical slip, for reconstructed stone and brick laying. Yield: 6-7 kg/m² according to the kind of support.

Putz-Kleber aus mineralischen Bindemitteln für professionellen Gebrauch, mit höchster Leistung, ohne vertikales Verrutschen, für die Verlegung von Kunststein und Kunstziegeln. Verbrauch: 6-7 kg/m², je nach Untergrund.

Colle-enduit de lissage professionnelle à base de liants minéraux, hautes performances, glissement vertical nul, pour la pose de pierres et briques reconstituées. Rendement: 6-7 kg/m² en fonction du type de support.

SPECIFICHE DI PRODOTTO - PRODUCT SPECIFICATIONS - ANGABEN ZUM PRODUKT - CARACTÉRISTIQUES DU PRODUIT

CONFEZIONE PACKAGING PACKUNG EMBALLAGE	PALLET PALLET PALETTE PALETTE	PREZZO A KG PRICE PER KG PREIS/KG PRIX AU KG	PREZZO A CONFEZIONE PRICE PER PACKAGING PREIS/PACKUNG PRIX PAR SAC
25 kg grigio	1500 kg	1,20 €	30,00 €
25 kg crema, marrone chiaro	1500 kg	1,30 €	32,50 €

ARREDOFIX



20 kg

8 kg



BIANCO

Adesivo in pasta ad elevate prestazioni pronto all'uso per la posa di pietre e mattoni ricostruiti. Da utilizzare per la posa su cartongesso. Resa: 3-4 kg/m² a seconda del tipo di supporto.

High performance ready-to-use adhesive paste for wall coverings laying of reconstructed stones and bricks. To be used for the laying onto plasterboard walls. Yield: 3-4 kg/m² according to the kind of support.

Sofort einsatzbereiter Pastenkleber mit höchster Leistung für die Verlegung von Kunststein und Kunstziegeln. Auf Verlegung von Gipsplatte benutzen. Verbrauch: 3-4 kg/m² je nach Untergrund.

Adhésif en pâte à hautes prestations prêt à l'usage pour la pose de pierres et briques reconstituées. À utiliser pour la pose sur placoplâtre. Rendement: 3-4 kg/m² selon le type de support.

SPECIFICHE DI PRODOTTO - PRODUCT SPECIFICATIONS - ANGABEN ZUM PRODUKT - CARACTÉRISTIQUES DU PRODUIT

CONFEZIONE PACKAGING PACKUNG EMBALLAGE	PALLET PALLET PALETTE PALETTE	PREZZO A KG PRICE PER KG PREIS/KG PRIX AU KG	PREZZO A CONFEZIONE PRICE PER PACKAGING PREIS/PACKUNG PRIX PAR SAC
8 kg bianco	512 kg	2,90 €	23,20 €
20 kg bianco	640 kg	2,40 €	48,00 €

per CARTONGESSO
onto PLASTERBOARD WALLS
für GIPSPAPPE
sur PLACOPLÂTRE

ARREDOSTUCCO



25 kg

Malta naturale colorata per la stuccatura ad alta traspirabilità di rivestimenti in pietra e mattoni ricostruiti. Resa: 8-12 kg/m² a seconda delle fughe.

Coloured natural mortar for high transpirability grouting of reconstructed stone and brick covering. Yield: 8-12 kg/m² depending on the joints.

Natürlicher, farbiger Mörtel für einen Verputz mit hoher Atmungsaktivität bei Belägen aus Kunststein und Kunstziegeln. Verbrauch: 8-12 kg/m² je nach den Fugen.

Mortier naturel coloré pour le jointoiment à haute transpirabilité de revêtements en pierres et briques reconstituées. Rendement: 8-12 kg/m² selon les joints.



PERLA

AVORIO

OCRA

GRIGIO

GRIGIO SCURO

SPECIFICHE DI PRODOTTO - PRODUCT SPECIFICATIONS - ANGABEN ZUM PRODUKT - CARACTÉRISTIQUES DU PRODUIT

CONFEZIONE PACKAGING PACKUNG EMBALLAGE	PALLET PALLET PALETTE PALETTE	PREZZO A KG PRICE PER KG PREIS/KG PRIX AU KG	PREZZO A CONFEZIONE PRICE PER PACKAGING PREIS/PACKUNG PRIX PAR SAC
25 kg avorio, ocra, perla grigio, grigio scuro	1500 kg	1,010 €	25,25 €
25 kg perla, grigio	1500 kg	1,010 €	25,25 €

ARREDOSTUCCO GRANA FINE

ARREDOLIGHT 0-3 mm / 3-6 mm



7,5 L

Inerte leggero da miscelare con ARREDOSTUCCO per la stuccatura di fughe tra pietre ricostruite. Aumenta la resa, favorisce la pulizia, migliora la traspirabilità e riduce i ponti termici. Da utilizzare per la posa su cappotto. Rapporto di miscelazione: 1 sacco di ARREDOSTUCCO (25 kg) + 1 sacco di ARREDOLIGHT (7,5 L).

Lightweight aggregate to be mixed with ARREDOSTUCCO for grouting reconstructed stone coverings. It increases the yield, helps cleaning, improves breathability and reduces thermal bridges. To be used for the laying of thermal insulation systems. Mixing ratio: 1 bag of ARREDOSTUCCO (25 kg) + 1 bag of ARREDOLIGHT (7,5 L).

Ausgewählter Leichtzuschlagstoff zum Vermischen mit dem Fugenmörtel ARREDOSTUCCO, für die Füllung zwischen den Kunststeinen. Erhöht die Leistung, hilft die Steinfläche sauber zu erhalten, verbessert die Atmungsfähigkeit, vermindert die Wärmebrücken. Auf Verlegung von Wärmedämmverbundsysteme benutzen. Mischungsverhältnis: 1 Sack ARREDOSTUCCO (25 kg) + 1 Sack ARREDOLIGHT (7,5 L).

Constituant inerte léger à mélanger avec ARREDOSTUCCO pour le jointoiment de pierres reconstituées. Il augmente le rendement, facilite le nettoyage, améliore la transpirabilité et réduit les ponts thermiques. À utiliser pour la pose sur isolant thermique. Rapport de mélange: 1 sac de ARREDOSTUCCO (25 kg) + 1 sac de ARREDOLIGHT (7,5 L).

SPECIFICHE DI PRODOTTO - PRODUCT SPECIFICATIONS - ANGABEN ZUM PRODUKT - CARACTÉRISTIQUES DU PRODUIT

CONFEZIONE PACKAGING PACKUNG EMBALLAGE	PALLET PALLET PALETTE PALETTE	PREZZO A KG PRICE PER KG PREIS/KG PRIX AU KG	PREZZO A CONFEZIONE PRICE PER PACKAGING PREIS/PACKUNG PRIX PAR SAC
7,5 l ≈ 5,50 kg	Nr. 60	1,010 €	5,55 €

per SISTEMI DI ISOLAMENTO TERMICO
for THERMAL INSULATION SYSTEMS
für WÄRMEDÄMMVERBUNDSYSTEME
pour ISOLATIONS THERMIQUES

ARREDOSIL



5 L

1 L

Impregnante siliconico incolore a base acquosa per la protezione idrorepellente di rivestimenti in pietra e mattoni ricostruiti. Resa: 0,250 kg/m².

Water based colourless silicone solution for water repellent protective treatment of reconstructed stone and brick facings. Yield: 0.250 kg/m².

Farblose Silikonimprägnierungsmittel auf Wasserbasis für erhöhte Wasserabweiskraft von Wandbelägen aus Kunststein und Kunstziegeln. Verbrauch: 0,250 kg/m².

Imprégnant silicone incolore à base d'eau pour la protection hydrofuge de revêtements en pierres et briques reconstituées. Rendement: 0,250 kg/m².

SPECIFICHE DI PRODOTTO - PRODUCT SPECIFICATIONS - ANGABEN ZUM PRODUKT - CARACTÉRISTIQUES DU PRODUIT

CONFEZIONE PACKAGING PACKUNG EMBALLAGE	PEZZI PER SCATOLA PIECES PER BOX STÜCK/SCHACHTEL PIÈCES PAR BOÎTE	PREZZO A LITRO PRICE PER LITRE PREIS/LITER PRIX AU LITRE	PREZZO A CONFEZIONE PRICE PER PACKAGING PREIS/PACKUNG PRIX PAR BOÎTE
1 L	Nr. 1	27,40 €	27,40 €
5 L	Nr. 1	23,00 €	115,00 €

ARREDOCOAT



5 L

1 L

Impregnante ad effetto bagnato per la protezione idrorepellente di rivestimenti in pietra e mattoni ricostruiti. Resa: 0,250 kg/m².

Impregnating agent conferring wet effect and water-repellence to reconstructed stone and brick facings. Yield: 0.250 kg/m².

Imprägnierungsmittel mit optischem Feuchtigkeitseffekt für erhöhte Wasserabweiskraft von Wandbelägen aus Kunststein und Kunstziegeln. Verbrauch: 0,250 kg/m².

Imprégnant à effet mouillé pour la protection hydrofuge de revêtements en pierres et briques reconstituées. Rendement: 0,250 kg/m².

SPECIFICHE DI PRODOTTO - PRODUCT SPECIFICATIONS - ANGABEN ZUM PRODUKT - CARACTÉRISTIQUES DU PRODUIT

CONFEZIONE PACKAGING PACKUNG EMBALLAGE	PEZZI PER SCATOLA PIECES PER BOX STÜCK/SCHACHTEL PIÈCES PAR BOÎTE	PREZZO A LITRO PRICE PER LITRE PREIS/LITER PRIX AU LITRE	PREZZO A CONFEZIONE PRICE PER PACKAGING PREIS/PACKUNG PRIX PAR BOÎTE
1 L	Nr. 4	27,40 €	109,60 €
	Nr. 14	27,40 €	383,60 €
5 L	Nr. 1	23,00 €	115,00 €
	Nr. 4	23,00 €	460,00 €

ARMOFLEX 330



50 m²

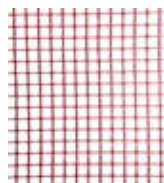

Rete tecnologica in fibra di vetro apprettata con elevata protezione agli alcali. Ideale per armare e rinforzare nei sistemi di isolamento a cappotto e su fondi con scarsa resistenza meccanica. Alta resistenza a trazione e al carico di rottura. Peso: 330 g/m².

Fibreglass technological mesh primed for high alkali resistance. Suitable to strengthen and reinforce insulation systems onto substrates with low mechanical resistance. High tensile strength and breaking load. Weight: 330 g/m².

Technologisches Glasfasernetz appetiert für einen hohen Schutz gegen Alkalien. Zur verstärkenden Armierung und Wärmedämmungsverkleidung und für Steigerung des mechanischen Widerstands des realisierten Belags, auch bei kritischen Betriebssituationen. Ausgezeichneter Widerstand gegen Zugbelastung und Zugfestigkeit. Gewicht: 330 g/m².

Treillis technologique en fibre de verre apprêté pour une haute protection contre les alcalis. Idéal comme armature de renfort pour systèmes d'isolation à manteau et sur fonds avec basse résistance mécanique. Haute résistance à la traction et à la charge de rupture. Poids: 330 g/m².

SPECIFICHE DI PRODOTTO - PRODUCT SPECIFICATIONS - ANGABEN ZUM PRODUKT - CARACTÉRISTIQUES DU PRODUIT

CONFEZIONE PACKAGING PACKUNG EMBALLAGE	PREZZO PRICE PREIS PRIX	PREZZO A CONFEZIONE PRICE PER PACKAGING PREIS/PACKUNG PRIX PAR EMBALLAGE
50,00 m ²	rotolo - roll Rolle - rouleau	7,00 €/m²
		350,00 €

SACCHETTI TRIANGOLARI



TRIANGULAR BAGS
SPRITZBEUTEL
SACS À POCHE

Sacchetti triangolari usa e getta in polietilene per iniettare lo stucco nei giunti di pietre e mattoni.

Disposable triangular polyethylene bags for grout injecting into stone and brick joints.

Einwegspritzbeutel aus PE für das Einbringen von Fugenmittel bei Stein-und Ziegelbelägen.

Sacs à poche jetables en polyéthylène pour injecter le produit de jointement dans les joints des pierres et des briques.

SPECIFICHE DI PRODOTTO - PRODUCT SPECIFICATIONS - ANGABEN ZUM PRODUKT - CARACTÉRISTIQUES DU PRODUIT

PEZZI PER SCATOLA PIECES PER BOX STÜCK/SCHACHTEL PIÈCES PAR BOÎTE	PREZZO A PEZZO PRICE PER PIECE PREIS/STÜCK PRIX PAR PIÈCE	PREZZO A SCATOLA PRICE PER BOX PREIS/SCHACHTEL PRIX PAR BOÎTE
Nr. 100	1,70 €	170,00 €

SACCHETTO TRIANGOLARE PROFESSIONALE



PROFESSIONAL TRIANGULAR BAG
PROFI-SPRITZBEUTEL
SAC À POCHE PROFESSIONNEL

Sacchetto triangolare in poliuretano leggero professionale per iniettare lo stucco nei giunti di pietre e mattoni.

Professional triangular light polyurethane bag for grout injecting into stone and brick joints.

Profi-Spritzbeutel aus leicht Polyurethan, um Stuck in die Fugen zwischen Steinen und Ziegeln spritzen zu können.

Sac à poche professionnel en polyuréthane léger pour injecter le produit de jointement dans les joints des pierres et des briques.

PREZZO A PEZZO | PRICE PER PIECE
PREIS/STÜCK | PRIX PAR PIÈCE

11,80 €

ROCKET TASSELLO A VITE

ROCKET DOWEL SCREW
ROCKET TELESKOP SCHRAUBDÜBEL VERSENKBAR
ROCKET CHEVILLE À VIS



Tassello a vite per montaggio a filo o a incasso nell'isolante con zona di espansione lunga. Per impiego universale su edifici nuovi e vecchi. Per calcestruzzo, mattoni pieni e forati, mattoni porizzati in laterizio e calcestruzzo cellulare. Profondità di annegamento: 25/65 mm. ETA 12/0334. Categoria di impiego: A/B/C/D/E. A Calcestruzzo / B Mattone pieno / C Mattone forato / D Calcestruzzo alleggerito / E Calcestruzzo aerato autoclavato.

Dowel screw for flush or recessed mounting into insulation with long expansion area. Universally applicable to new and old buildings. Suitable for concrete, for solid, hollow and porous bricks, as well as for aerated concrete. Anchoring depth: 25/65 mm. ETA 12/0334. Category of use: A/B/C/D/E. A Concrete / B Solid brick / C Hollow Brick / D Light concrete / E Autoclaved aerated concrete.

Versenkbarer Schraubdübel geeignet zur Erröten-Einfassung oder zur Unterputzmontage in der Dämmdicke mit langem Spreizbereich. Universell einsetzbar im Neu- und Altbau, insbesondere geeignet für unverputzte und verputzte Beton-, Vollstein- und Ziegeluntergründe sowie Porenbeton. Verankerungstiefe: 25/65 mm. ETA 12/0334. Nutzungskategorie: A/B/C/D/E. A Beton / B Vollziegel / C Lochziegel / D Leichtbeton / E Porenbeton.

Cheville à vis pour montage à filet sur mur ou à emboîtement avec zone d'expansion longue. Pour emploi universel sur bâtiments nouveaux et vieux. Pour béton, briques pleines et creuses, aussi bien que pour briques poreuses en terre cuite et béton cellulaire. Profondeur d'ancrage: 25/65 mm. ETA 12/0334. Catégorie d'emploi: A/B/C/D/E. A Béton / B Brique pleine / C Brique creuse / D Béton léger / E Béton cellulaire autoclavé.

	SPESSORE MASSIMO ISOLANTE MAXIMUM THICKNESS OF THE INSULATION MAXIMALE DICKE DER ISOLIERUNG ÉPAISSEUR MAXIMALE DE L'ISOLANT	PZ/SCATOLA QTY/BOX STCK/SCHACHTEL PIÈCES/BOÎTE	€/SCATOLA €/BOX €/SCHACHTEL €/BOÎTE
ROCKET 95	40 mm	200	119,00
ROCKET 115	60 mm	200	133,00
ROCKET 135	80 mm	200	153,00
ROCKET 155	100 mm	200	173,00
ROCKET 175	120 mm	200	200,00
ROCKET 195	140 mm	200	230,00
ROCKET 215	160 mm	200	265,00

ROCKET WOOD TASSELLO A VITE PER LEGNO

ROCKET WOOD DOWEL SCREW FOR WOODEN SUBSTRATES
ROCKET WOOD HOLZSCHRAUBE FÜR HOLZBEFESTIGUNGEN
ROCKET WOOD CHEVILLE À VIS POUR LA FIXATION SUR BOIS



Tassello a rondella, con testa da 60 mm, chiodo a vite truciolare per il fissaggio dei pannelli isolanti su supporti in legno e dotata di tappo per la riduzione dei ponti termici. Realizzato in PP (polipropilene).

Screw fastener with washer, diameter 60mm, particle board screw nail for fixing insulation boards on wooden supports and equipped with cap to reduce thermal bridges. Made of PP (polypropylene).

Dübel mit Unterlegscheibe, 60mm Kopf, Spanplatten-Schraubennagel zur Befestigung von Dämmplatten auf Holzstützen und ausgestattet mit Kappe zur Reduzierung von Wärmebrücken. Hergestellt aus PP (Polypropylen).

Cheville à rosace, diamètre 60 mm, clou à vis auto-perceuse pour la fixation de panneaux d'isolation sur supports en bois et équipé d'un capuchon pour réduire les ponts thermiques. Fabriqué en PP (polypropylène).

	COLORE COLOUR FARBE COULEUR	MISURE MEASURES MASSNAHMEN MESURES	PZ/SCATOLA QTY/BOX STCK/SCHACHTEL PIÈCES/BOÎTE	€/SCATOLA €/BOX €/SCHACHTEL €/BOÎTE
TASSELLO PER FISSAGGIO SU LEGNO	bianco / white weiß / blanc	15 x 60 mm	1000	340,00
VITE TRUCIOLARE ZINCATA	acciaio steel Stahlfarbe acier	50 x ø 5 mm	200	20,400
VITE TRUCIOLARE ZINCATA		60 x ø 5 mm	200	40,800
VITE TRUCIOLARE ZINCATA		70 x ø 5 mm	200	61,200
VITE TRUCIOLARE ZINCATA		80 x ø 5 mm	200	47,600
VITE TRUCIOLARE ZINCATA		90 x ø 5 mm	200	54,400
VITE TRUCIOLARE ZINCATA		100 x ø 5 mm	100	27,200
VITE TRUCIOLARE ZINCATA		120 x ø 6 mm	100	44,200
VITE TRUCIOLARE ZINCATA		140 x ø 6 mm	100	68,000
VITE TRUCIOLARE ZINCATA		160 x ø 6 mm	100	95,200
VITE TRUCIOLARE ZINCATA		180 x ø 6 mm	100	142,80
VITE TRUCIOLARE ZINCATA		200 x ø 6 mm	100	217,60

CONDIZIONI GENERALI DI VENDITA | GENERAL TRADE CONDITIONS
ALLGEMEINE GESCHÄFTSBEDINGUNGEN | CONDITIONS GENERALES DE VENTE

Quantità minima di spedizione: una scatola. Per ordini di valore inferiore a 150,00 € verranno addebitati 15,00 € + IVA a titolo di contributo per spese di gestione. Tutte le confezioni s'intendono comprensive di fuga da 1 cm ± 5%. Il quantitativo dell'ordine verrà arrotondato in funzione al contenuto delle confezioni. I consumi di Arredocolla e Arredostucco indicati nel presente listino sono indicativi in quanto essi possono variare a seconda del supporto e dell'ampiezza della fuga. L'acquirente ha l'obbligo di controllare la qualità e la quantità della merce al momento della consegna. Eventuali ammanchi o vizi devono essere trascritti nel d.d.t.

Non si accettano reclami di nessun genere su: materiale posato in opera; materiali conformi all'ordine; distacchi o macchiature della pietra se non posata con Arredocolla, Arredofix e Arredostucco. I prezzi s'intendono franco nostro deposito di Roteglia (RE) o Gubbio (PG). Per qualsiasi controversia il Foro competente è quello di Perugia.

Alcune sfumature più scure, che possono essere notate sul materiale acquistato, potrebbero essere causate da una non perfetta asciugatura del prodotto e tenderanno a scomparire con il passare del tempo.

IL PRESENTE LISTINO ANNULLA E SOSTITUISCE TUTTI I PRECEDENTI.

The minimum quantities to be ordered: one box. Orders under € 150,00 will automatically have a fixed charge of € 15,00 invoiced. The surface indicated in the packaging section includes both stones and joints of 1 cm ± 5%. The orders will be made even to the packaging content. The consumption of Arredocolla and Arredostucco indicated in this price list is approximate as it may vary depending on the surface and the size of the joint. The purchaser is obliged to check the quality and quantity of goods at the moment of delivery. Possible defects must be pointed out on the delivery document.

No complaints will be accepted for: goods conforming to the orders; installed stone or its detachments if not laid with Arredocolla, Arredofix and Arredostucco. The prices are intended EXW our warehouse of Roteglia (RE) or Gubbio (PG). For any controversy the Court of Perugia will have jurisdiction.

The darker shade of delivered material may be caused by its not completed curing and it will get regular over time.

THIS PRICE LIST CANCELS AND REPLACES THE PREVIOUS ONES.

Mindestmenge für den Versand: eine Verpackung. Für Bestellungen bis 150,00 € eingeschlossen werden zusätzlich 15,00 € als Beitrag für die Betriebskosten berechnet. Die Packungsberechnung geht immer von 1 cm breiten Fugen ± 5% einschließlich aus. Die Bestellmenge wird in Abhängigkeit von der Menge in der Packung gerundet. Der Verbrauch von Arredocolla und Arredostucco, der in der Preisliste enthalten ist, ist nur ein Richtwert, der sich je nach Untergrund und Größe der Fuge ändern kann. Der Käufer ist verpflichtet, die Ware bei Erhalt auf Qualität und Menge zu kontrollieren. Eventuelle Fehlmengen oder Fehler müssen umgehend in das Versanddokument eingetragen werden.

Nichtakzeptiert werden: Reklamationen zu verlegtem Material, Rückgabe von bestellungsgemäß geliefertem Material; Reklamationen im Falle von Ablösungen oder Verfleckungen von Steinen, die nicht mit Arredocolla, Arredofix und Arredostucco verlegt worden sind. Alle Preise verstehen sich ab unserem Lager in Roteglia (RE) oder Gubbio (PG). Gerichtsstand ist Perugia.

Eine dunklere Tönung des erworbenen Materials kann mitunter durch nicht vollständiges Austrocknen der Ware vor dem Versand entstehen und verschwindet mit der Zeit von selbst.

DIE VORLIEGENDE PREISLISTE ERSETZT ALLE VORHERIGEN PREISLISTEN UND HAT ALLEINIGE GÜLTIGKEIT.

Quantité minimum expédiée: une boîte. Les commandes avec montant inférieur à 150,00 € seront majorées de 15,00 €. Tous emballages comprennent un joint de 1 cm ± 5%. La quantité de la commande est arrondie en fonction du contenu des emballages. Les rendements de Arredocolla et Arredostucco sont indicatifs car ils peuvent changer selon le support ou l'ampleur du joint. Lors de la livraison, l'acheteur s'engage à contrôler la qualité et la quantité de la marchandise. Les quantités éventuellement manquantes ou les défauts doivent être mentionnés dans le Bon de Livraison.

Aucune réclamation concernant le matériel mis en oeuvre, marchandise conforme à la commande, les décollements ou les taches de la pierre ne sera recevable si la pose n'a pas été effectuée avec Arredocolla, Arredofix et Arredostucco. Les prix s'entendent départ usine de Roteglia (RE) ou Gubbio (PG). En cas de litige, le seul tribunal compétent est celui de Perugia.

Certaines nuances plus foncées constatées sur le matériel acheté pourraient être dues à un séchage incomplet du produit. Elles iront disparaître au fil du temps.

LE PRESENT TARIF ANNULE ET REMPLACE TOUS LES PRECEDENTS.

NOTE | NOTES
ANMERKUNGEN | NOTES

PIETRA RICOSTRUITA DA RIVESTIMENTO | RECONSTRUCTED STONE FACINGS
KUNSTSTEIN FÜR WANDBELAG | PIERRE RECONSTITUÉE POUR PAREMENT MURAL

ELEMENTI SPECIALI | SPECIAL ELEMENTS
SONDERELEMENTE | ÉLÉMENTS PARTICULIERS

SISTEMI INNOVATIVI | INNOVATION SYSTEMS
INNOVATIVE SYSTEME | SYSTÈMES INNOVANTS

PRODOTTI TECNICI | TECHNICAL PRODUCTS
TECHNISCHE PRODUKTE | PRODUITS TECHNIQUES

COLLEZIONE	ELEMENTO PIANO	ELEMENTO ANGOLARE
ALPINO	121,80 €/m ²	74,20 €/m
ANTICO MATTONE	101,60 €/m ²	69,00 €/m
ARENAL	114,20 €/m ²	73,20 €/m
BELMONTE	121,80 €/m ²	74,20 €/m
BORGONOVO	121,80 €/m ²	74,20 €/m
CALEPIO	114,20 €/m ²	73,20 €/m
CANOVA	121,80 €/m ²	74,20 €/m
CERVINO	118,30 €/m ²	73,20 €/m
CERVINO PANEL	118,30 €/m ²	73,20 €/m
CERVINO PANEL PEZZO SPECIALE	6,400 €/Nr	
CORTEVECCHIO	121,80 €/m ²	74,20 €/m
CORTONA	121,80 €/m ²	74,20 €/m
DOLOMITE	121,80 €/m ²	74,20 €/m
ETRUSCO	121,80 €/m ²	74,20 €/m
GRANADA	115,80 €/m ²	73,20 €/m
JAVA	118,30 €/m ²	73,20 €/m
KALOS	116,20 €/m ²	47,20 €/m
LIGURE	122,80 €/m ²	74,20 €/m
LOKON	118,30 €/m ²	73,20 €/m
LOKON ANTRACITE	123,50 €/m ²	73,20 €/m
MADERA	118,30 €/m ²	73,20 €/m
MISTO A RICHIESTA	128,80 €/m ²	74,20 €/m
MISTO CAMPAGNA MISCELATO	121,60 €/m ²	74,20 €/m
MISTO CAMPAGNA DA MISCELARE	115,00 €/m ²	73,20 €/m
MISTO UMBRO MISCELATO	121,60 €/m ²	74,20 €/m
MISTO UMBRO DA MISCELARE	115,00 €/m ²	73,20 €/m
MONTANO	121,80 €/m ²	74,20 €/m
MURIA	108,00 €/m ²	73,20 €/m
OLKARIA	118,10 €/m ²	73,20 €/m
OLKARIA ANTRACITE	123,50 €/m ²	73,20 €/m
RUSTICO	96,90 €/m ²	66,00 €/m
SAKAR	110,70 €/m ²	73,20 €/m
SAKAR ANTRACITE	118,70 €/m ²	73,20 €/m
SANTIAGO	117,30 €/m ²	73,20 €/m
SASSO DI FIUME	118,30 €/m ²	73,20 €/m
TAOS	115,20 €/m ²	73,20 €/m
TEIDE	117,30 €/m ²	73,20 €/m
TIROLESE	121,80 €/m ²	74,20 €/m
TOSCANO	121,80 €/m ²	74,20 €/m
VENETO	121,80 €/m ²	74,20 €/m
VESUVIO	111,70 €/m ²	73,20 €/m
VINTAGE	115,40 €/m ²	-
VICTORY	105,10 €/m ²	70,00 €/m

PRODOTTI	CONFEZIONE	PREZZO	PREZZO/CONFEZIONE
ARMOFLEX 330	50 m ²	7,000 €/m²	350,00 €
ARREDOCOLLA GRIGIO	25 kg	1,200 €/kg	30,00 €
ARREDOCOLLA CREMA/MARRONE CHIARO	25 kg	1,300 €/kg	32,50 €
ARREDOCOAT	1 L x 4 pz	27,400 €/L	109,60 €
ARREDOCOAT	1 L x 14 pz	27,400 €/L	383,60 €
ARREDOCOAT	5 L x 1 pz	23,000 €/L	115,00 €
ARREDOCOAT	5 L x 4 pz	23,000 €/L	460,00 €
ARREDOFIX BIANCO	8 kg	2,900 €/kg	23,20 €
ARREDOFIX BIANCO	20 kg	2,400 €/kg	48,00 €
ARREDOLIGHT	7,50 L ≈ 5,50 kg	1,010 €/kg	5,55 €
ARREDOSIL	1 L	27,400 €/L	27,40 €
ARREDOSIL	5 L	23,000 €/L	115,00 €
ARREDOSTUCCO	25 kg	1,010 €/kg	25,25 €
ARREDOSTUCCO GRANA FINE PERLA/GRIGIO	25 kg	1,010 €/kg	25,25 €
ELEMENTO AQUA	1 pz	64,000 €/pz	64,00 €
ELEMENTO SAVANA	1 pz	117,500 €/pz	117,50 €
KRONOS	1 pz	107,200 €/pz	107,20 €
ROCKET 95	200 pz/scatola	0,595 €/pz	119,00 €
ROCKET 115	200 pz/scatola	0,665 €/pz	133,00€
ROCKET 135	200 pz/scatola	0,765 €/pz	153,00 €
ROCKET 155	200 pz/scatola	0,865 €/pz	173,00 €
ROCKET 175	200 pz/scatola	1,000 €/pz	200,00 €
ROCKET 195	200 pz/scatola	1,150 €/pz	230,00 €
ROCKET 215	200 pz/scatola	1,325 €/pz	265,00 €
SACCHETTI TRIANGOLARI	100 pz/scatola	1,700 €/pz	170,00 €
SACCHETTO TRIANGOLARE PROFESSIONALE	1 pz/scatola	11,800 €/pz	11,80 €
TASSELLO PER FISSAGGIO SU LEGNO	1000 pz/scatola	0,34 €/pz	340,00
TERMINALE ELEMENTO ANGOLARE	12 pz/scatola	18,600 €/pz	223,20 €
TERMINALE ELEMENTO PIANO	8 pz/scatola	16,500 €/pz	132,00 €
VITE TRUCIOLARE ZINCATA 50 x ø 5 mm	200 pz/scatola	0,102 €/pz	20,400 €
VITE TRUCIOLARE ZINCATA 60 x ø 5 mm	200 pz/scatola	0,204 €/pz	40,800 €
VITE TRUCIOLARE ZINCATA 70 x ø 5 mm	200 pz/scatola	0,306 €/pz	61,200 €
VITE TRUCIOLARE ZINCATA 80 x ø 5 mm	200 pz/scatola	0,238 €/pz	47,600 €
VITE TRUCIOLARE ZINCATA 90 x ø 5 mm	200 pz/scatola	0,272 €/pz	54,400 €
VITE TRUCIOLARE ZINCATA 100 x ø 5 mm	100 pz/scatola	0,272 €/pz	27,200 €
VITE TRUCIOLARE ZINCATA 120 x ø 6 mm	100 pz/scatola	0,442 €/pz	44,200 €
VITE TRUCIOLARE ZINCATA 140 x ø 6 mm	100 pz/scatola	0,680 €/pz	68,000 €
VITE TRUCIOLARE ZINCATA 160 x ø 6 mm	100 pz/scatola	0,952 €/pz	95,200 €
VITE TRUCIOLARE ZINCATA 180 x ø 6 mm	100 pz/scatola	1,428 €/pz	142,80 €
VITE TRUCIOLARE ZINCATA 200 x ø 6 mm	100 pz/scatola	2,176 €/pz	217,60 €

Pietre d'Arredo[®]

naturalmente ricostruite

www.pietredarredo.it | info@pietredarredo.it

 *Pietre D'Arredo*  *pietredarredo*

UFFICI COMMERCIALI, DEPOSITI E SHOW ROOM

Gubbio (PG)

Z. I. Padule, Via Topino, n. 11 - 06024 - Gubbio - ITALY
tel. +39 075 923561 - fax +39 075 9221174

Sassuolo (MO)

Via Regina Pacis, n. 226 - 41049 - Sassuolo - ITALY

bimobject[®]

archiproducts[®]

edilportale[®]
il motore di ricerca dell'edilizia

DISTRIBUIDOR PENINSULA IBERICA:

FUTURE EURO TRADE S.L.

C.tra Vila-Real - Onda, Km. 6,00 - 12200 Onda (Castellón) - Spain

tel: +34 964 626795 - fax: +34 964 626178

info@fetfuture.com - www.futurepedradesign.com - www.fetfuture.com

powered by

COLMEF
— group —

Colmef srl - Z. I. Ponte d'Assi - 06024 Gubbio (PG) - ITALY - tel. +39 075 923561 - info@colmef.com

Pietred'Arredo[®]
naturalmente ricostruite

www.pietredarredo.com | info@pietredarredo.com